

Bi-spectrum Network Camera User Manual

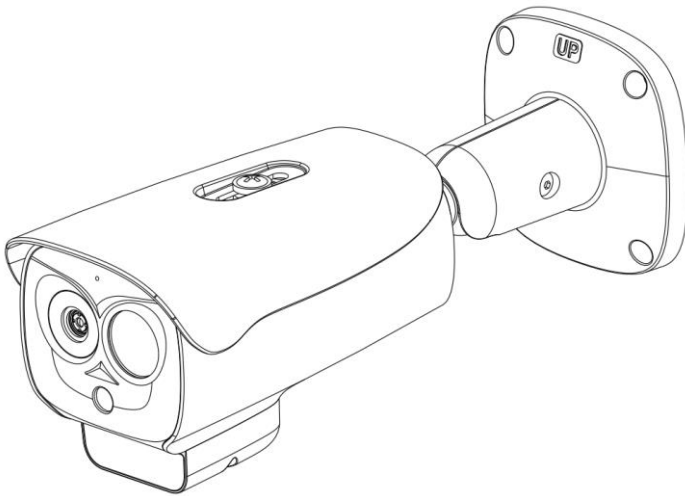

Issue V 1.0

Data 2022-08-04





Precautions

Precautions

Fully understand this document before using this device, and strictly observe rules in this document when using this device. If you install this device in public places, provide the tip "You have entered the area of electronic surveillance" in an eye-catching place. Failure to correctly use electrical products may cause fire and severe injuries. To prevent accidents, carefully read the following context:

Symbols

This document may contain the following symbols whose meanings are described accordingly.

Symbol	Description
 DANGER	It alerts you to fatal dangers which, if not avoided, may cause deaths or severe injuries.
 WARNING	It alerts you to moderate dangers which, if not avoided, may cause minor or moderate injuries.
 CAUTION	It alerts you to risks. Neglect of these risks may cause device damage, data loss, device performance deterioration, or unpredictable results.
 TIP	It provides a tip that may help you resolve problems or save time.
 NOTE	It provides additional information.



DANGER

To prevent electric shocks or other dangers, keep power plugs dry and clean.



WARNING

- Strictly observe installation requirements when installing the device. The manufacturer shall not be held responsible for device damage caused by users' non-conformance to these requirements.

- Strictly conform to local electrical safety standards and use power adapters which are marked with the LPS standard when installing and using this device. Otherwise, this device may be damaged.
- Use accessories delivered with this device. The voltage must meet input voltage requirements for this device.
- If this device is installed in places with unsteady voltage, ground the device to discharge high energy such as electrical surges in order to prevent the power supply from burning out.
- When this device is in use, ensure that no water or any liquid flows into the device. If water or liquid unexpectedly flows into the device, immediately power off the device and disconnect all cables (such as power cables and network cables) from this device.
- Do not place the thermal imaging camera and unpackaged products at a radiation source with a high intensity regardless of whether the device is in the normal power-on state, for example, the sun, laser, and electric arc welder, and place the thermal imaging camera and unpackaged products against objects with a high heat source, for example, the sun. Otherwise, the accuracy of the thermal imaging camera will be affected. In addition, the detector in the thermal imaging camera may be permanently damaged.
- If this device is installed in places where thunder and lightning frequently occur, ground the device nearby to discharge high energy such as thunder strikes in order to prevent device damage.



CAUTION

- Unless otherwise specified in the user manual, do not use the thermal imaging camera in an environment with the temperature lower than -20°C (-4°F) or higher than 60°C ($+140^{\circ}\text{F}$). Otherwise, the images displayed by the thermal imaging camera are abnormal and the device may be damaged if working beyond the temperature range for a long period.
- During the outdoor installation, prevent the morning or evening sunlight incidence to the lens of the thermal imaging camera. The sun shade must be installed and adjusted according to the angle of the sunlight illumination.
- Avoid heavy loads, intensive shakes, and soaking to prevent damages during transportation and storage. The warranty does not cover any device damage that is caused during secondary packaging and transportation after the original packaging is taken apart.
- This device is a static sensitivity device. Improper static may damage the thermal imaging camera. ESD protection measures and reliable grounding must be well prepared for device installation and uninstallation.
- Protect this device from fall-down and intensive strikes, keep the device away from magnetic field interference, and do not install the device in places with shaking surfaces or under shocks.
- Use a soft and dry cloth to clean the device body. In case that the dirt is hard to remove, use a dry cloth dipped in a small amount of mild detergent and gently wipe

the device, and then dry it again. Pay special attention to the front window of the thermal imaging camera because this is precision optics. If the front window has water spots, use a clean and soft cloth moistened with water to wipe it. If the front window needs further cleaning, use a soft cloth dampened with isopropyl alcohol or detergent. Improper cleaning can cause damage to the device.

- The lens window of the thermal imaging camera is designed to be applicable to an outdoor environment. The window is coated with durable coating material, but may require frequent cleaning. When you found lens image degradation or excessive accumulation of pollutants, you should clear up the window in a timely manner. Exercise caution when you use this device in severe sandstorm (such as deserts) or corrosive environments (such as offshore). Improper use may cause surface coating off.
- Do not jam the ventilation opening. Follow the installation instructions provided in this document when installing the device.
- Keep the device away from heat sources such as radiators, electric heaters, or other heat equipment.
- Keep the device away from moist, dusty, extremely hot or cold places, or places with strong electric radiation.
- If the device is installed outdoors, take insect- and moisture-proof measures to avoid circuit board corrosion that can affect monitoring.
- Remove the power plug if the device is idle for a long time.
- Before unpacking, check whether the fragile sticker is damaged. If the fragile sticker is damaged, contact customer services or sales personnel. The manufacturer shall not be held responsible for any artificial damage of the fragile sticker.

Special Announcement

All complete products sold by the manufacturer are delivered along with nameplates, operation instructions, and accessories after strict inspection. The manufacturer shall not be held responsible for counterfeit products.

This manual may contain misprints, technology information that is not accurate enough, or product function and operation description that is slightly inconsistent with the actual product. The manufacturer will update this manual according to product function enhancement or changes and regularly update the software and hardware described in this manual. Update information will be added to new versions of this manual without prior notice.

This manual is only for reference and does not ensure that the information is totally consistent with the actual product. For consistency, see the actual product.

Contents

Precautions	I
Contents	IV
1 Product Overview	7
1.1 About Product.....	7
1.2 Device Dimension	7
1.3 Installation.....	8
1.4 Cable Connection	10
2 Quick Configuration	14
2.1 Login and Logout	14
2.2 Homepage Layout	15
2.3 Changing the Password	17
2.4 Browse Video	18
2.4.1 Install Plugins.....	20
2.5 Personnel Count	21
2.6 Setting Local Network Parameters	22
3 Temperature Measurement	25
3.1 Temperature Parameters	25
3.2 Ambient Temperature	31
3.3 Temperature Area	32
3.4 Shield Area.....	36
3.5 Schedule Linkage	37
3.6 Thermal Mapping.....	45
3.7 Bad Point Check.....	47
3.8 LED Control Param.....	49
3.9 Digital Tube.....	50
4 Visible Sensor Configuration	52
4.1 Accessing the Sensor Interface	52
4.2 Mode	53
4.3 Image Adjust	54

4.4 Scene	56
4.5 Exposure.....	57
4.6 WB	59
4.7 DayNight	61
4.8 Noise Reduction	63
4.9 Enhance Image	64
5 Thermal Sensor Configuration.....	66
5.1 Accessing the Sensor Interface	66
5.2 Mode	67
5.3 Images	68
5.4 Scene	70
5.5 Set Pseudocolor	71
5.6 FFC Control	72
5.7 Noise Reduction	75
6 Intelligent Analysis	77
6.1 Perimeter	77
6.2 Single Virtual Fence	81
6.3 Double Virtual Fences	85
6.4 Personnel Count	86
6.5 Enter Area.....	90
7 Advanced Intelligent Analysis.....	92
7.1 Smoker Detection	92
7.2 Smoke and Flame Detection.....	96
7.3 Fire Spot Detection.....	99
8 AI Multi-object.....	103
9 Alarm Setting.....	105
9.1 Alarm Output.....	105
9.2 Disk Alarm	106
9.3 Network Alarm	106
9.4 I/O Alarm Linkage	107
9.5 Motion Alarm	108
9.6 Push Message	109
9.7 Audio Abnormal Output	110
10 Other Web Configurations.....	112
10.1 Device Information.....	112

10.2 Stream	113
10.2.1 Base Stream.....	113
10.2.2 ROI.....	114
10.2.3 Snapshot.....	115
10.3 Device	116
10.4 External Device	116
10.5 Privacy Masking.....	118
10.6 Network Service	118
10.7 Privacy Manager	118
10.8 Protocol	119
10.9 Device Log	120
10.10 Maintenance	120
10.11 Local Config.....	121
10.12 QOS.....	122
A Troubleshooting.....	124

1 Product Overview

1.1 About Product

- The Bi-spectrum network camera is integrated with the thermal imaging and temperature measuring, visible fusion, core image intelligent analysis, etc.
- Unique double registration mechanism, visible light and thermal imaging is reflecting the same scene.
- The Bi-spectrum network camera is high precision, built-in automatic temperature correction, completely eliminate the temperature drift, it can work stable and reliable for long time.
- Intelligent temperature and visible light image channel display details information to easily monitor and discriminate.
- Smart over temperature alarm and location, sound and light alarm, track rapidly when temperature was abnormal.

It can be widely used in important fields such as airports, stations, urban roads, traffic surveys, corporate security, warehouse monitoring, and residential security.

1.2 Device Dimension

Figure 1-1 shows the dimensions of device.

Figure 1-1 Dimensions (unit: mm)

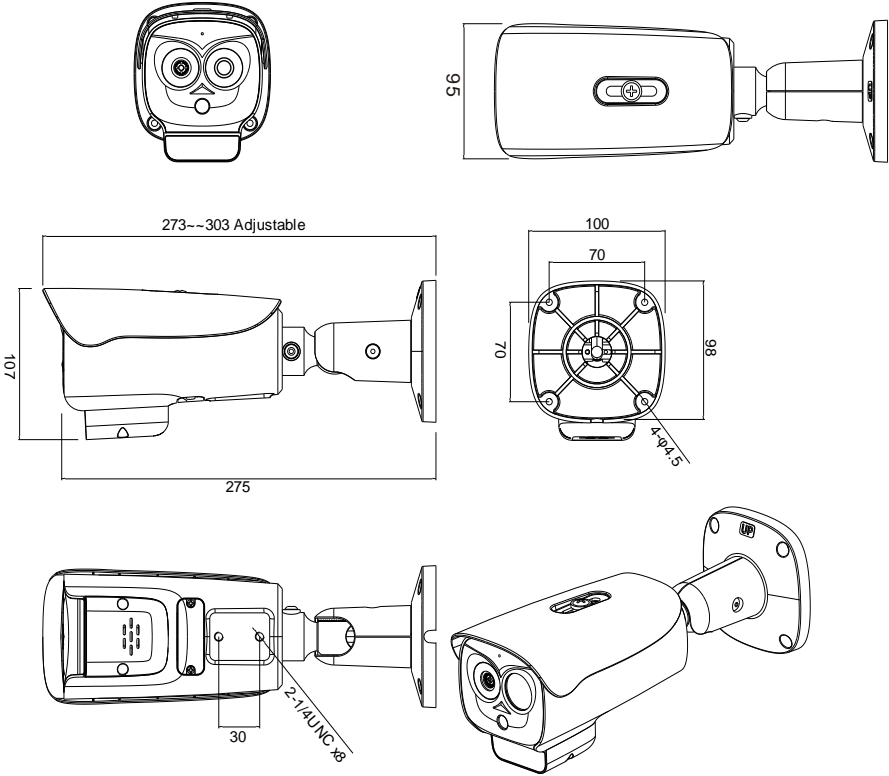

1.3 Installation

- Step 1 Stick the installation location sticker on ceiling or wall, drill four holes based on the marks on the sticker. Drive the swell plastic buttons into holes.
- Step 2 Loosen screw 1 to free the body to easy to install the fixed screws of camera. This step before mount is highly suggested to make it convenient to use electric screwdriver, as shown in Figure 1-2.

Figure 1-2 Adjust direction

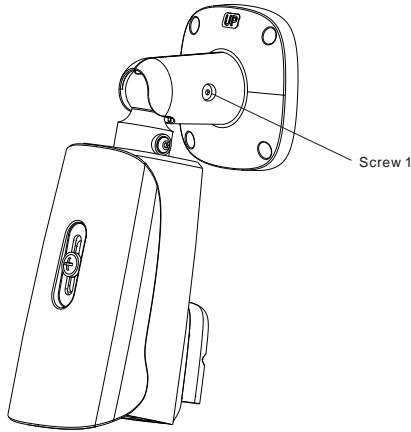

Step 3 Install the camera on the ceiling or wall and fix the screws as shown in Figure 1-3.

Figure 1-3 Fix camera

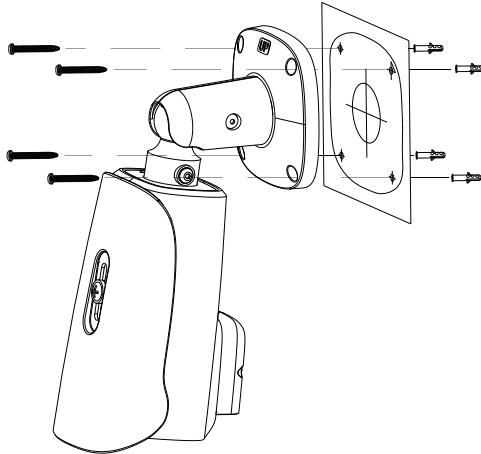

Step 4 Connect the multi-connector cable and monitor, loosen the screw 2 to adjust the position so that the camera face the monitored area, as shown in Figure 1-4. Tighten the screw 1 and screw 2.

Figure 1-4 Adjust image

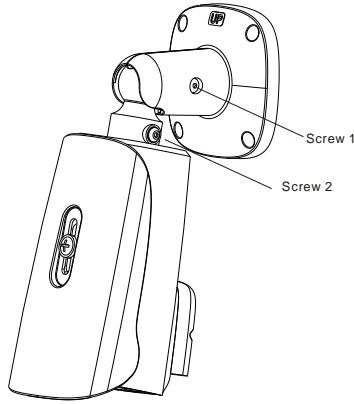

1.4 Cable Connection

 **NOTE**

The different models may have different cables, please refer to actual product.

Figure 1-5 Multi-connector combination cable

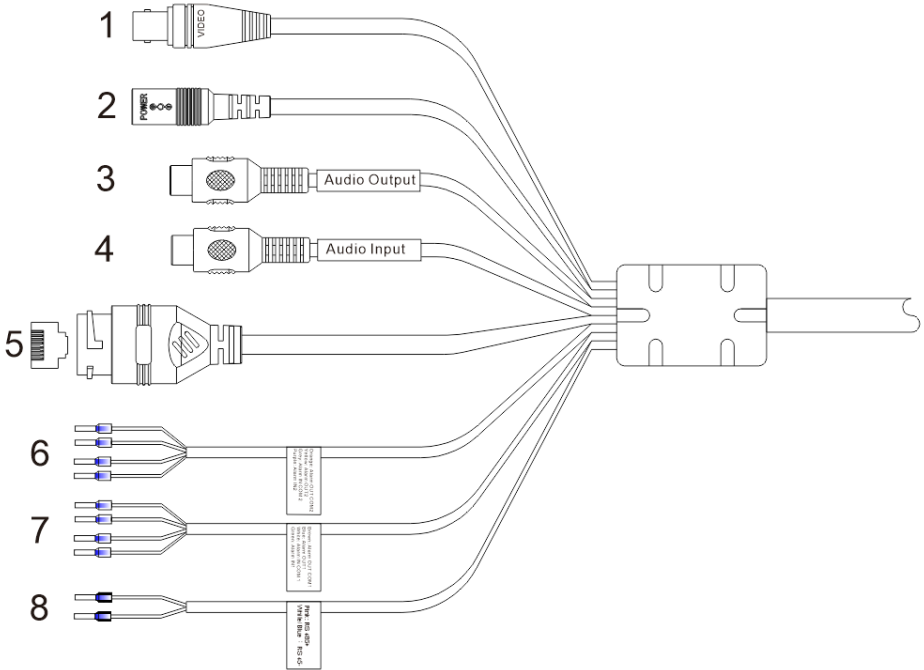

Table 1-1 Multi-connector combination cable

ID	Core of Cable	Functions
1	Analog Video Output	Connect the BNC connector. Some models may not have this cable, please refer to actual product.
2	DC12V (2A)	Power interface, connects to the 12 V DC power supply.
3	Audio Input	Input the audio signal and receives the analog audio signals from the sound pick-up device.
4	Audio Output	Connect to the external audio device such as the voice box.
5	Network interface	Connect to the standard Ethernet cable.
6	ALARM 2	Alarm in/ alarm out 2 Orange: alarm OUT COM 2 Yellow: alarm OUT 2

		Grey: alarm IN COM 2 Purple: alarm IN 2
7	ALARM1	Alarm in/ alarm out 1 Brown: alarm OUT COM 1 Blue: alarm OUT 1 White: alarm IN COM 1 Green: alarm IN 1
8	RS485	RS485 interface connects to the external pan & tilt.

Figure 1-6 Multi-connector combination cables 2

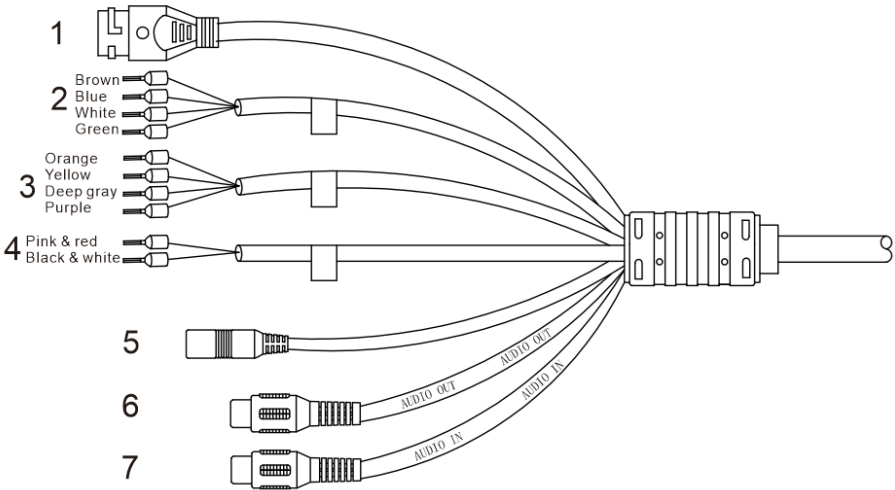

Table 1-2 Multi-connector combination cables 2

ID	Core of Cable	Functions
1	Network interface	Connect to the standard Ethernet cable. Support PoE power supply.
2	ALARM1	Alarm in/ alarm out 1 Brown: alarm OUT COM 1 Blue: alarm OUT 1 White: alarm IN COM 1 Green: alarm IN 1

3	ALARM 2	Alarm in/ alarm out 2 Orange: alarm OUT COM 2 Yellow: alarm OUT 2 Grey: alarm IN COM 2 Purple : alarm IN 2
4	RS485	RS485 interface connects to the external pan & tilt. Pink & red is RS485+ Black & white is RS485-
5	DC12V (2A)	Power interface, connects to the 12 V DC power supply.
6	Audio Output	Connect to the external audio device such as the voice box.
7	Audio Input	Input the audio signal and receives the analog audio signals from the sound pick-up device.

2 Quick Configuration

2.1 Login and Logout



CAUTION

To access the web interface through Edge browser (IE Mode); Otherwise, some functions may be unavailable.

Login system

Step 1 Open the Microsoft Edge, enter the IP address of IP camera (default value: 192.168.0.121) in the address box, and press Enter.

The login page is displayed, as shown in Figure 2-1.

Figure 2-1 Login page

The screenshot shows the login interface for an IP camera. It features a light blue header with the text 'IP CAMERA' in a large, bold, blue font. To the right of the header, there is a language selection dropdown menu currently set to 'English'. Below the header, there are two input fields: 'User Name' and 'Password'. To the right of these input fields is a blue button with a white right-pointing arrow, which is used to submit the login credentials.

Step 2 Input the User and password.

 **NOTE**

- Access the web at Edge browser which the mode should switch to **Reload in Internet Explorer mode**. At browser “Setting > Default browser” page, **Let Internet Explorer open sites in Microsoft Edge** choose “Always (Recommended)”; **Allow sites to be reloaded in Internet Explorer mode (IE mode)** choose “Allow”.

Figure 2-2 Internet Explorer compatibility

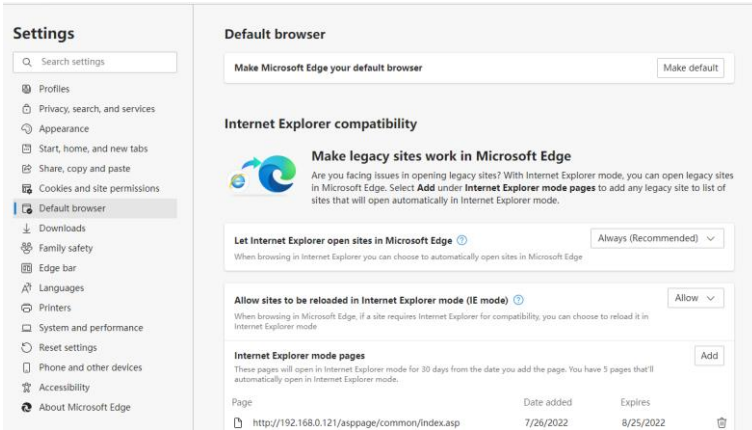

- The default name and password are both admin. Modify the password when you login the system for first time to ensure system security.
- After modifying password, you need to wait at least three minutes then power off to make sure modifying successfully . Or login the Web again to test the new password.
- You can change the system display language on the login page.

Step 3 Click Login arrow to enter main interface.

----End

Logout

Click  in the top right to back to Web Login.

----End







2.2 Homepage Layout



On the homepage, user can view real-time video, playback, personnel Count and configuration. User can set Sensor parameters, Video parameter, Video control, and logout of the system. Figure 2-3 is shown the homepage layout. Table 2-1 lists the elements on the homepage layout.

Figure 2-3 Homepage layout



Table 2-1 Elements on the homepage

NO.	Element	Description
1	Real-time video area	Real-time videos are played in this area. You can also set sensor parameters. The two channels are displaying at the same time.
2	Playback	You can query the playback videos in this area.
3	Configuration	You can choose a menu to set device parameters, including the device information, audio and video streams, alarm setting, and privacy mask function.
4	Change password	You can click  to change the password.
5	Sign Out	You can click  to return to the login page.
6	Channel	Channel 1: visible light. Channel 2: thermal image.
7	Stream	Four streams. You can set details at configuration base stream interface. Stream 4 is SVC stream.
8	-	 : Play/pause.  : Switch the mode.  : Audio.  : Interphone.  : Sensor, or click right mouse button, more details

NO.	Element	Description
		please refer to chapter 4 <i>Visible Sensor Configuration</i> and <i>Configuration Thermal5 Thermal Sensor Configuration</i> .  : Snapshot.  : Record video to local storage.  : Intelligent analysis, Choose the stream to stream 2, click to open the intelligent analysis, it will show target information and video stream draw line after you have turned on the function in IAS settings.

When the device generates an alarm, the alarm icon  is displayed. You can click  to view the alarm information.

 **NOTE**

When the device accepts an alarm signal, the alarm icon will display within 10s in the web management system.

----End

2.3 Changing the Password

Description

User can click  to change the password for logging into the system.

Procedure

Step 1 Click  in the upper right corner of the main page.

The **Change Password** dialog box is displayed, as shown in Figure 2-4.

Figure 2-4 Change password dialog box

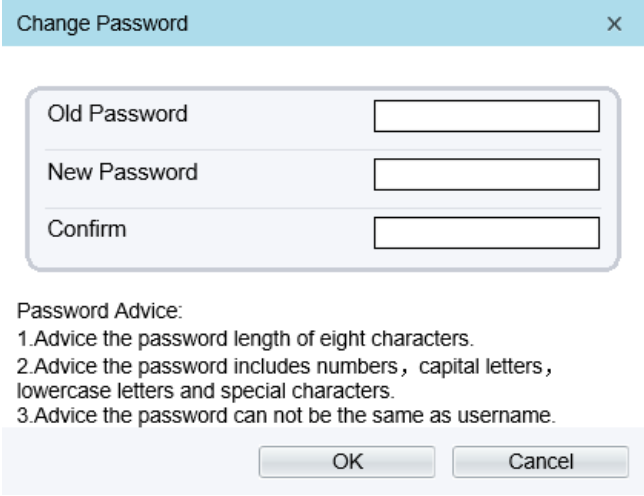

The image shows a 'Change Password' dialog box with a light blue header and a close button (X) in the top right corner. The main area contains three input fields: 'Old Password', 'New Password', and 'Confirm', each with a corresponding text label to its left. Below the input fields, there is a section titled 'Password Advice:' followed by three numbered instructions: 1. Advice the password length of eight characters. 2. Advice the password includes numbers, capital letters, lowercase letters and special characters. 3. Advice the password can not be the same as username. At the bottom of the dialog box, there are two buttons: 'OK' and 'Cancel'.

**NOTE**

- The change password page will be displayed if you don't change the default password when you login the system for the first time.

Step 2 Input the old password, new password, and confirm password.

Step 3 Click **OK**.

If the message "**Change password success**" is displayed, the password is successfully changed. If the password fails to be changed, the cause is displayed. (For example, the new password length couldn't be less than eight.)

----End

2.4 Browse Video

User can browse the real-time video in the web management system.

Preparation

To ensure the real-time video can be played properly, you must perform the following operations when you log in to the web for the first time:

Step 1 Open Microsoft Edge. Choose **Control Panel > Internet options > Security > Trusted sites > Sites**.

In the display dialog box, click **Add**, as shown in Figure 2-5.

Figure 2-5 Adding a trusted site

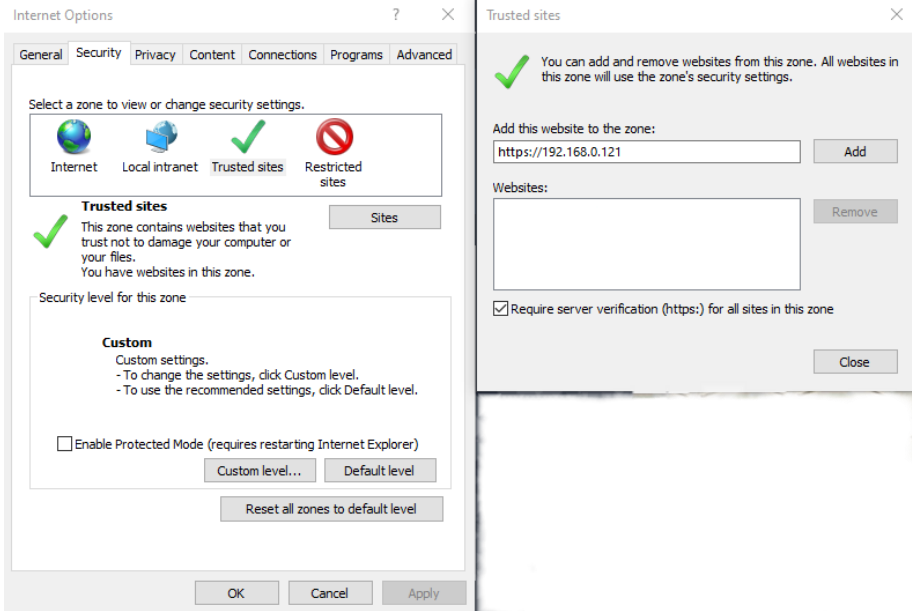

Step 2 In Microsoft Edge, choose **Control Panel > Internet Options > Security > Customer level**, and set Download unsigned ActiveX control and initialize and script ActiveX controls not marked as safe for scripting under ActiveX controls and plug-ins to Enable, as shown in Figure 2-6.

Figure 2-6 Configuring ActiveX control and plug-ins

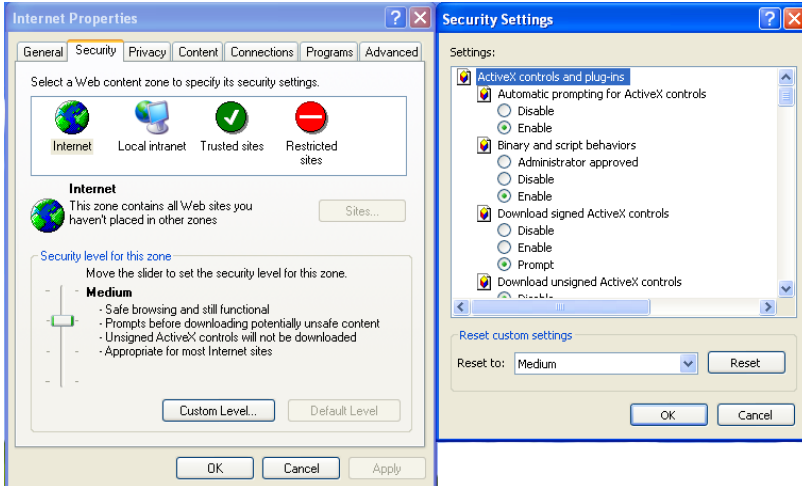

Step 3 Download and install the player control as prompted.

NOTE

- The login page is displayed when the control is loaded.
- If you can view the live video immediately, you can ignore the steps of adding trust site.

2.4.1 Install Plugins

You will be prompted with a message “Download and install the new plugin” as shown in Figure 2-7 when you log in to the web management system for the first time.

Figure 2-7 Download the plugin page



Procedure

- Step 1 Click the message, download and install the plugin follow the prompts.
- Step 2 Reopen the browser after installation.
- Step 3 On live video page, you can operate these buttons as shown in live video.

NOTE

- Channel switch, click the live video, the red frame means the chosen channel.
- During installing plugins, you need to close the browser, finish the installation, login the device again.

----End

2.5 Personnel Count

At **personnel count** interface, you can view the personnel count throughout setting query condition (choose the detail time at date's pop up window).

There are three modes to show the data, such as line chart, histogram, and list, as shown in Figure 2-8.

Figure 2-8 Personnel count interface

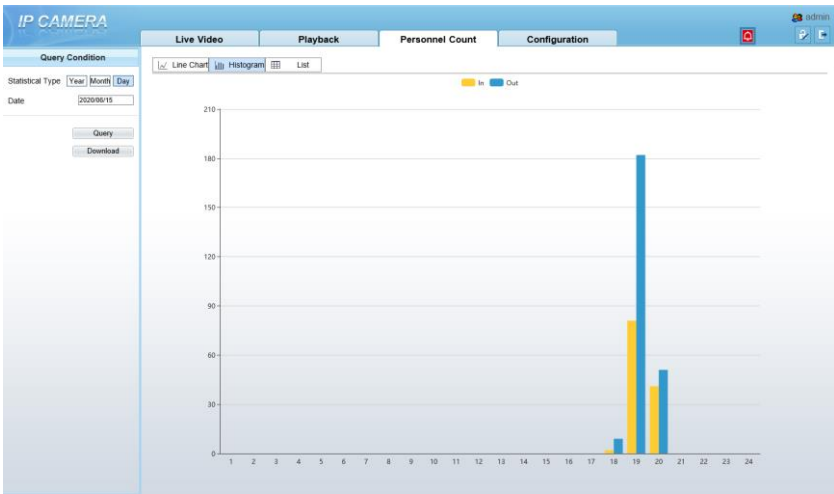

Click “Download” to download the query result.

Choose the mode of showing result, such as line chart, histogram, list.

Click “Query” to query the data of personnel count.

User can download the result to local folder.

----End

2.6 Setting Local Network Parameters

Description

Local network parameters include:

- IP protocol
- IP address
- Subnet mask
- Default gateway
- Dynamic Host Configuration Protocol (DHCP)
- Preferred Domain Name System (DNS) server
- Alternate DNS server
- MTU

Procedure

Step 1 Choose **Configuration > Device > Local Network**.

The **Local Network** page is displayed, as shown in Figure 2-9.

Figure 2-9 Local network

Local Network

Network Card ID: 1

IP Protocol: IPv4

DHCP: OFF

IP Address: 192.168.0.121

Subnet Mask: 255.255.255.0

Default Gateway: 192.168.0.1

Preferred DNS Server: 192.168.0.1

Alternate DNS Server: 192.168.0.2

MTU(1280-1500): 1500

Refresh Apply

Step 2 Set the parameters according to Table 2-2.

Table 2-2 Local network parameters

Parameter	Description	Setting
IP Protocol	IPv4 is the IP protocol that uses an address length of 32 bits.	[Setting method] Select a value from the drop-down list box. [Default value] IPv4
DHCP	The device automatically obtains the IP address from the DHCP server.	[Setting method] Click the option button. NOTE To query the current IP address of the device, you must query it on the platform based on the device name.
DHCP IP	IP address that the DHCP server assigned to the device.	N/A
IP Address	Device IP address that can be set as required.	[Setting method] Enter a value manually. [Default value] 192.168.0.121
Subnet Mask	Subnet mask of the network adapter.	[Setting method] Enter a value manually. [Default value] 255.255.255.0

Parameter	Description	Setting
Default Gateway	This parameter must be set if the client accesses the device through a gateway.	[Setting method] Enter a value manually. [Default value] 192.168.0.1
Preferred DNS Server	IP address of a DNS server.	[Setting method] Enter a value manually. [Default value] 192.168.0.1
Alternate DNS Server	IP address of a domain server. If the preferred DNS server is faulty, the device uses the alternate DNS server to resolve domain names.	[Setting method] Enter a value manually. [Default value] 192.168.0.2
MTU	Set the maximum value of network transmission data packets.	[Setting method] Enter a value manually. NOTE The MTU value is range from 1280 to 1500, the default value is 1500, Please do not change it arbitrarily.

Step 3 Click **OK**.

- If the message "**Apply success**" is displayed, click OK. The system saves the settings. The message "**Set network param's success, Please login system again**" is displayed. Use the new IP address to log in to the web management system.
- If the message "Invalid IP Address", "**Invalid Subnet Mask**", "**Invalid default gateway**", "**Invalid primary DNS**", or "**Invalid space DNS**" is displayed, set the parameters correctly.



NOTE

- If you set only the Subnet Mask, Default Gateway, Preferred DNS Server, and Alternate DNS Server parameters, you do not need to login to the system again.
- You can click Reset to restore the previous parameters if required.

----End

3 Temperature Measurement

3.1 Temperature Parameters

Temperature parameters include temperature unit, ambient type, ambient temperature, cavity temperature, correctional coefficient, area temperature display mode, area temperature type, measure mode, and area alarm interval.

Operation Procedure

Step 1 Choose **Configuration >Thermal >Temperature Parameters**.

The **Temperature Parameters** page is displayed, as shown in Figure 3-1.

Figure 3-1 Temperature parameters interface

 Temperature Parameters

Open Temperature Measure	<input checked="" type="checkbox"/>
Temperature Units	Celsius
Length Units	Meters
Cavity Temperature	34.95
Correction Coefficient	0.00
Area ID Display Mode	Area ID
Area Temperature Display Mode	Low Left
Font Border	<input checked="" type="checkbox"/>
Font Size	Mid
Area Temperature Type	Highest Temperature & ...
Measure Mode	General
Display Alarm Area	<input type="checkbox"/>
Area Alarm Interval(1-1800S)	10
Area Alarm Delay(0-10Sec)	0
Temperature Range	-40.0 ~ 150.0
Prevent Over Heat	Auto
Temper Duration(5-60Sec)	60

Step 2 Set the parameters according to Table 3-1.

Table 3-1 Temperature parameters

Parameter	Description	Setting
Temperature Unit	Celsius and Fahrenheit temperature units are available.	[Setting method] Select a value from the drop-down list box. [Default value] Celsius

Parameter	Description	Setting
Length Units	The unit of distance	[Setting method] Select a value from the drop-down list box. [Default value] Meters
Cavity Temperature	The cavity temperature of camera.	N/A
Correction Coefficient	Correction coefficient is refer to the deviation of measured object temperature and actual temperature, is offset value. For example: 1. The measured object temperature is 36.0, and actual temperature is 36.5, so the correction coefficient should be 0.5 . 2. The measured object temperature is 37.3, and actual temperature is 36.5, so the correction coefficient should be -0.8. NOTE User should contact the technical support staff of our company at this condition to make sure to apply	[Setting method] Enter a value manually. [Default value] 0.00
Area ID display mode	There two mode to display, area ID and area name	[Setting method] Select a value from the drop-down list box. [Default value] Area ID
Area Temperature Display Mode	The display position of temperature information on the live-video image.	[Setting method] Select a value from the drop-down list box. [Default value] Low left
Font Border	Enable to bold the font	[Setting method] Enable or disable [Default value] Disable

Parameter	Description	Setting
Font size	Choose the size of font	[Setting method] Select a value from the drop-down list box. [Default value] Mid
Area Temperature Type	There are three types of area temperature.	[Setting method] Select a value from the drop-down list box. [Default value] Highest Temperature
Measure Mode	There are two types of measure modes.	[Setting method] Select a value from the drop-down list box. [Default value] General
Display Alarm Area	N/A	[Setting method] Enable or disable [Default value] Disable
Area Alarm Interval (1-1800s)	N/A	[Setting method] Enter a value manually ranges from 1 to 1800. [Default value] 10
Area Alarm delay(0-10sec)	N/A	[Setting method] Enter a value manually ranges from 1 to 10. [Default value] 0
Temperature range	It depends on the device. Different devices have different modes, there are two ranges, such as -20 °C -150°C, -40 °C-150°C, the thermal imaging box network camera is -40 °C-150°C.	[Setting method] Select a value from the drop-down list box.

Parameter	Description	Setting
Prevent Over Heat	Open, if temperature of the testing area is too high, you can enable prevent over heat function, there are two types, manual and auto. The auto mode is advised.	[Setting method] Select a value from the drop-down list box.
Temper Duration(5-60 S)	Prevent over heat' mode is auto, the control cover will block for duration time automatically if over heat.	[Setting method] Enter a value manually ranges from 5 to 60.
Control Cover	It is professional operation. When prevent over heat mode is manual, the user should choose the action manually, such as pick up, lay down.	[Setting method] Select a value from the drop-down list box.

Figure 3-2 Advanced interface

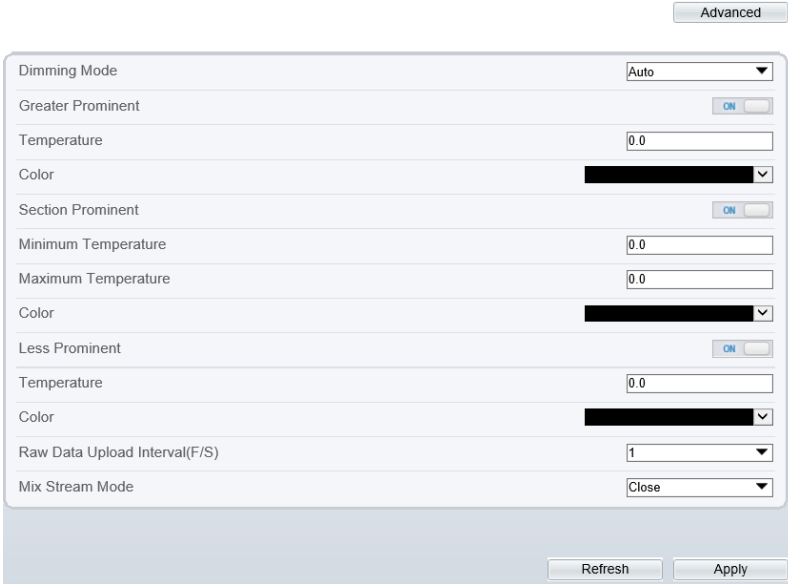

Table 3-2 Advance parameters

Parameter	Description	Setting
Dimming Mode	There are auto and manual modes. It will show on temperature item.	[Setting method] Select a value from the drop-down list box. [Default value] Auto
Greater Prominent	Enable that, the image will show the setting color if the temperature is higher than set value.	[Setting method] Enter a value manually. Choose one color to show.
Section Prominent	Enable that, the image will show the setting color if the temperature is between minimum and maximum temperature.	[Setting method] Enter a value manually. Choose one color to show.
Less Prominent	Enable that, the image will show the setting color if the temperature is lower than set value.	[Setting method] Enter a value manually. Choose one color to show.

Parameter	Description	Setting
Raw Data Upload Interval(F/S)	Interval of Uploading the raw data.	[Setting method] Select a value from the drop-down list box. [Default value] 1
Mix Stream Mode	This function is used for thermal and visible image to mix.	[Default value] Close

----End

3.2 Ambient Temperature

Figure 3-3 Ambient temperature

Ambient Temperature

Ambient Temperature °C

Adaptation Environment Temperature °C

Table 3-3 Parameter of ambient temperature

Parameter	Description	Setting
Ambient Temperature	Environment temperature of camera.	[Setting method] Enter the temperature of ambient. [Default value] 25
Adaptation environment temperature	Set the ambient temperature, click “Apply”, click “Refresh”, the camera will get the value automatically.	---

----End

3.3 Temperature Area

Operation Procedure

Step 1 Choose **Configuration >Thermal >Temperature Area**.

The **Temperature Area** page is displayed, as shown in Figure 3-4.

Figure 3-4 Temperature area and alarm configuration

Temperature Area And Alarm Configuration

Channel 2
Measure Mode General



Temperature data overlay:

```

[00] 42.7
[01] 36.5
[02] 29.4
[03] 32.9
            
```

-
+
 6



[*]
[+]
[]
[]
A
[]

Enable	ID	Name	Type	Alarm Type	Warning Value	Alarm Value	Maximum Alarm Va	Duration(1-1)
<input checked="" type="checkbox"/>	0	Area0	Rectangle	Threshold Alarm	48.00	50.00	60.00	1.00
<input checked="" type="checkbox"/>	1	Area1	Polygon	Threshold Alarm	48.00	50.00	60.00	1.00
<input checked="" type="checkbox"/>	2	Area2	Polygon	Threshold Alarm	48.00	50.00	60.00	1.00
<input checked="" type="checkbox"/>	3	Area3	Line	Threshold Alarm	48.00	50.00	60.00	1.00
<input type="checkbox"/>	4	Area4	Point	Threshold Alarm	48.00	50.00	60.00	1.00
<input type="checkbox"/>	5	Area5	Point	Threshold Alarm	48.00	50.00	60.00	1.00
<input type="checkbox"/>	6	Area6	Point	Threshold Alarm	48.00	50.00	60.00	1.00

Step 2 Set the parameters according to Table 3-4.

Table 3-4 Temperature area and alarm configuration

Parameter	Description	Setting
Channel	Channel 1 is visible light channel. Channel 2 is thermal channel.	[Setting method] Select a value from the drop-down list box. [Default value] 2
Measure Mode	Set at temperature parameter interface.	N/A
Enable	Tick the ID to enable the area measuring.	[Setting method] Tick
Name	Area name of temperature area.	[Setting method] Enter a value manually.
Type	Type of temperature area. ID 0 is default rectangle area, which is full screen.	[Setting method] Select a value from the drop-down list box. [Default value] Rectangle/Point
Alarm Type	Threshold alarm, temperature difference alarm, section alarm, temperature rise alarm are available for alarm type. Section Alarm: if the temperature value is among the set temperature range, it will generate the alarm. Temperature rise alarm means if the rising temperature value is more than the set value, it will generate the alarm.	[Setting method] Select a value from the drop-down list box. [Default value] Threshold alarm
Warning Value	Camera will trigger warning alarm when the object temperature reaches the warning value.	[Setting method] Enter a value manually. [Default value] 48
Alarm Value	Camera will alarm when the object temperature reaches the alarm value.	[Setting method] Enter a value manually. [Default value] 50

Parameter	Description	Setting
Maximum Alarm Value	At section alarm type, the device would not alarm when the temperature is higher than maximum alarm value.	[Setting method] Enter a value manually. [Default value] 60.00
Duration (1-10S)	Choose temperature rise alarm, set the duration, the temperature rise the value and it is kept for duration setting, the alarm is triggered successfully.	[Setting method] Enter a value manually. [Default value] 1.00
Emission Rate	The emission rate is the capability of an object to emit or absorb energy. The emission rate should be set only when the target is special material.	[Setting method] Enter a value manually. [Default value] 0.95
Distance(M)	The distance between camera and target.	[Setting method] Enter a value manually. [Default value] 15  NOTE Enter actual distance when the distance between camera and target is less than 15m. Enter 15 when the distance between camera and target is great than or equal to 15m.
Alarm	Enable or disable the alarm output and linkage of area.	[Setting method] Tick the alarm output channel .

Step 3 Set temperature area.

Tick an area ID.

Press and hold the left mouse button, and drag in the video area to draw a temperature area, as shown in Figure 3-5. Right-click to finish the area selected.

Figure 3-5 Temperature area setting interface

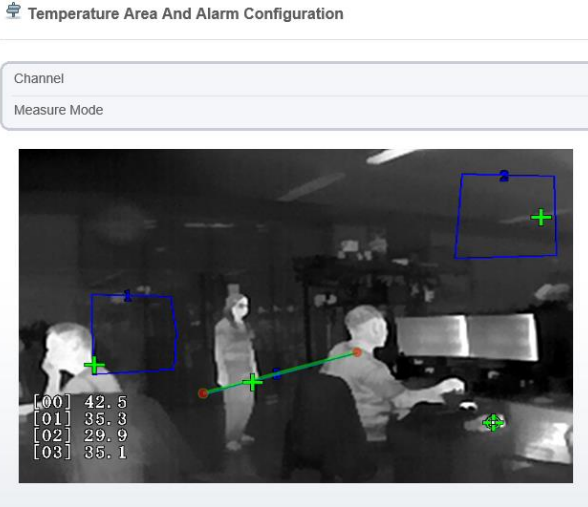

Click **Apply**, the message “Apply success” is displayed, the temperature area is set successfully.

 **NOTE**

ID 0 is the full screen; the area cannot be changed.



: the lowest temperature of the full screen.



:the highest temperature of the full screen.



: the lowest temperature of the area.



: the highest temperature of the area.

Delete a temperature area:

Select an area ID.

Click the temperature area and right-click.

Remove the tick of area ID.

Click **Apply**, the message “Apply success” is displayed, the temperature area is deleted successfully.

Step 4 Click **Apply**.

The message "Apply success" is displayed, the system saves the settings.

----End

3.4 Shield Area

Shield area is meaning that the camera will do not detect the temperature of that area.
The shield areas can be set up to four areas.

Operation Procedure

Step 1 Choose **Configuration > Thermal > Shield Area**.

Figure 3-6 Shield area



Step 2 Enable the shield area.

Step 3 Enable **Show Shield Area**, then the setting shield will show on live video.

Step 4 Click left mouse button to set area; click right mouse button to end the setting.

Step 5 Click **Clear** to clear the shield area.

----End

3.5 Schedule Linkage

There are six types schedule linkage to set, like threshold alarm, threshold warning, temperature difference alarm, temperature difference warning, temperature section alarm, temperature rise alarm and temperature rise warning.

Operation Procedure

Step 1 Choose **Configuration > Thermal > Schedule Linkage**.

The **Schedule Linkage** page is displayed, as shown in Figure 3-7. Tick the output channel if user connects the external alarm device. It can also enable alarm record, SMTP, FTP upload, audio alarm and flashlight alarm.

Figure 3-7 Schedule linkage

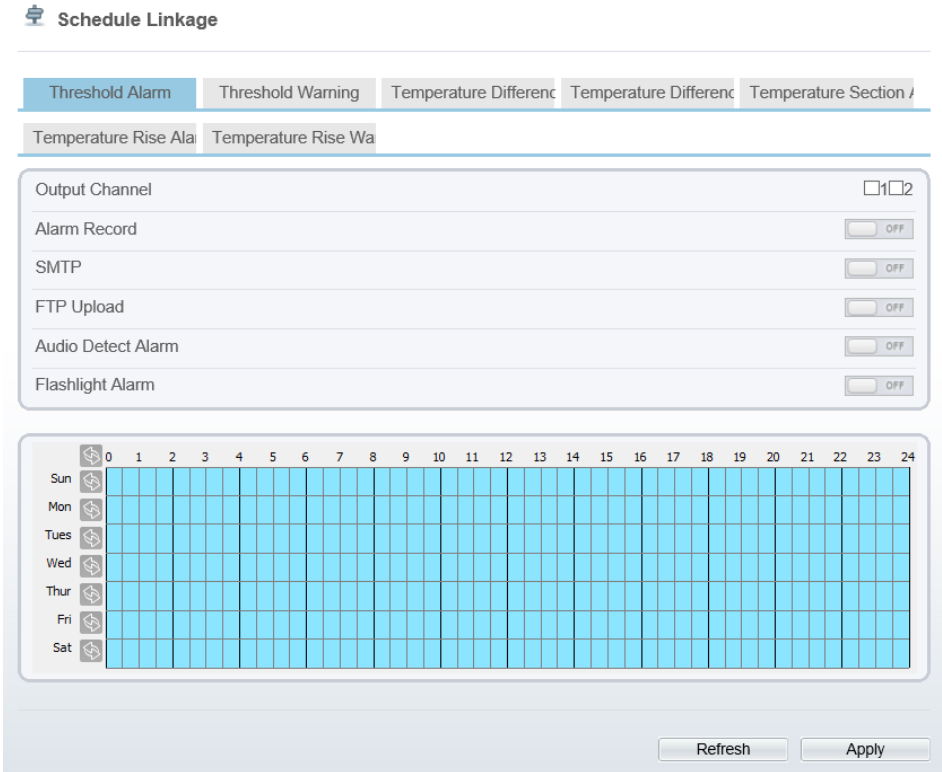

Step 2 Tick the output channel. Enable alarm record, SMTP, FTP upload, audio alarm and flashlight alarm.

Step 3 Set schedule linkage.

Method 1: Click left mouse button to select any time point within 0:00-24:00 from Monday to Sunday as shown in Figure 3-7.

Method 2: Hold down the left mouse button, drag and release mouse to select the alarm time within 0:00-24:00 from Monday to Sunday.

 **NOTE**

When you select time by dragging the cursor, the cursor cannot be moved out of the time area. Otherwise, no time can be selected.

Method 3: Click  in the alarm time page to select the whole day or whole week.

Deleting alarm time: Click  again or inverse selection to delete the selected alarm time.

Step 4 Click **Apply**.

The message "Apply success" is displayed, the system saves the settings.

 **NOTE**

- Alarm output: Users should connect the external alarm device (such as siren) to alarm output cables. The parameter can be set at “ Configuration > Alarm > Alarm Output” interface, as shown in Figure 3-8.

Figure 3-8 Alarm output

The screenshot shows the 'Alarm Output' configuration page. It includes a title bar with a gear icon and the text 'Alarm Output'. The main form contains several input fields: 'Alarm Output' with a dropdown menu showing '1', 'Name' with an empty text box, 'Valid Signal' with a dropdown menu showing 'Close', 'Alarm Output Mode' with a dropdown menu showing 'Switch Mode', and 'Alarm Time(ms)(0:Continuous)' with a text box containing '0'. Below the main form are two sections: 'Timing Alarm Output' with a toggle switch set to 'OFF', and 'Manual control' with 'Start' and 'Stop' buttons. At the bottom of the page are 'Refresh' and 'Apply' buttons.

Table 3-5 Alarm output

Parameter	Description	Setting
Alarm Output	ID of the alarm output channel. NOTE The number of alarm output channels depends on the device model.	[Setting method] Select a value from the drop-down list box. [Default value] 1
Name	Alarm output channel name.	[Value range] 0 to 32 bytes
Valid Signal	The options are as follows: Close: An alarm is generated when an external alarm signal is received. Open: An alarm is generated when no external alarm signal is received.	[Setting method] Select a value from the drop-down list box. [Default value] Close

Parameter	Description	Setting
Alarm Output Mode	<p>When the device receives I/O alarm signals, the device sends the alarm information to an external alarm device in the mode specified by this parameter. The options include the switch mode and pulse mode.</p> <p>NOTE</p> <ul style="list-style-type: none"> • If the switch mode is used, the alarm frequency of the device must be the same as that of the external alarm device. • If the pulse mode is used, the alarm frequency of the external alarm device can be configured. 	<p>[Setting method] Select a value from the drop-down list box. [Default value] Switch Mode</p>
Alarm Time (ms) (0: Continuous)	Alarm output duration. The value 0 indicates that the alarm remains valid.	<p>[Setting method] Enter a value manually. [Default value] 0 [Value range] 0 to 86400 seconds</p>
Timing Alarm Output	Enable timing alarm output, set the schedule to time alarm.	<p>[Setting method] Enable [Default value] OFF</p>
Manual Control	Control the alarm output.	N/A

- Alarm Record: Users insert the SD card in camera. The recording time is set at “ **Configuration > Device Record > Record Policy**” interface.
- SMTP: At “ **Configuration > Network > SNMP**” interface, users should set the parameters of SMTP in advance, as shown in Figure 3-9.

Figure 3-9 SMTP

The screenshot shows the SMTP configuration page. It features several input fields: SMTP Server Address, SMTP Server Port (with a default value of 25), User Name, Password, and a checkbox for 'Send anonymously'. Below these are five recipient email address fields (Recipient_E-mail_Address1 to 5) and a 'Sender E-mail Address' field. A 'Transport Mode' dropdown menu is set to 'No Encrypt', and a 'Send Interval(0-60S)' field is set to 0. At the bottom, there are 'Email Test', 'Refresh', and 'Apply' buttons.

Table 3-6 SMTP parameters

Parameter	Description	Setting
SMTP Server Address	IP address of the SMTP server.	[Setting method] Enter a value manually.
SMTP Server Port	Port number of the SMTP server.	[Setting method] Enter a value manually. [Default value] 25
User Name	User name of the mailbox for sending emails.	[Setting method] Enter a value manually.
Password	Password of the mailbox for sending emails.	[Setting method] Enter a value manually.
Sender E-mail Address	Mailbox for sending emails.	[Setting method] Enter a value manually.

Parameter	Description	Setting
Recipient_ E-mail_Address 1	(Mandatory) Email address of recipient 1.	[Setting method] Enter a value manually.
Recipient_ E-mail_Address 2	(Optional) Email address of recipient 2.	
Recipient_ E-mail_Address3	(Optional) Email address of recipient 3.	
Recipient_ E-mail_Address 4	(Optional) Email address of recipient 4.	
Recipient_ E-mail_Address 5	(Optional) Email address of recipient 5.	
Attachment Image Quality	A higher-quality image means more storage space. Set this parameter based on the site requirement.	N/A
Transport Mode	Email encryption mode. Set this parameter based on the encryption modes supported by the SMTP server.	[Setting method] Select a value from the drop-down list box. [Default value] No Encrypted

- FTP Upload: At “**Configuration > Network > FTP Upload**” interface, users should set the parameters of FTP upload in advance, as shown in Figure 3-10.

Figure 3-10 FTP upload

























Table 3-7 FTP upload parameters







Parameter	Description	Setting
FTP Upload	Indicates whether to enable the FTP service.	[Setting method] Click the button on. [Default value] OFF
FTP Address	IP address of FTP server.	[Setting method] Enter a value annually.
FTP Port	Port of FTP server.	[Setting method] N/A [Default value] 21
Account	FTP server account.	[Setting method] Enter a value annually.
Password	FTP server Password.	[Setting method] Enter a value annually.
FTP Path	FTP Path to save the JPG image.	[Setting method] Enter a value annually.
Media type	The media type of sending to FTP, snapshot or video clip.	[Setting method] Select a value from the drop-down list box. [Default value] Snapshot

- Audio Detect Alarm: At “**Configuration > Alarm > Sound Alarm Output**” interface, users should set the parameters of sound Alarm output in advance, as shown in Figure 3-11.

Figure 3-11 Sound alarm output

 Sound Alarm Output

ID	FileName	Cycle Number	Listen Test	Operate
0	high_temperature_alarm.wav	1		
1	normal_temperature.wav	1		
2	low_temperature_alarm.wav	1		
3	hello_welcome.wav	1		
4	verification_success.wav	1		
5	verification_failed.wav	1		
6	temperature_rise_warning.wav	1		
7	temperature_rise_alarm.wav	1		
8	temperature_range_alarm.wav	1		
9	temperature_diff_alarm.wav	1		
10	temperature_diff_warning.wav	1		
11	high_temperature_warning.wav	1		
12	fire_detected_please_process_immediately.wav	1		
13	smoking_is_prohibited_in_this_area.wav	1		

	0	1	2	3	4	5	6	7	8	9	10	11	12	13	14	15	16	17	18	19	20	21	22	23	24
Sun																									
Mon																									
Tues																									
Wed																									
Thur																									
Fri																									
Sat																									



User can set the audio file manually. Click  to upload the audio file(The type should be WAV, size must be less than 250 Kb, the bit rate should be 128 kbps.), as shown in Figure 3-12.

Figure 3-12 Upload audio file

Upload Audio File ✕

Please select audio file 

Flashlight Alarm: At “**Configuration > Thermal > Led Control Param**” interface, set the flashlight alarm mode. The Display Mode choose mode 5 (When alarm triggered, the Led light will keep on for 20s), the Led light will be on when the alarm is triggered. If the Led display mode is not set as Mode 5, the default status is flicker when the alarm is triggered.

Figure 3-13 Led control parameter

Led Control Param

ID	0
Display Mode	Mode5
Brightness	39

Refresh Apply

----End

3.6 Thermal Mapping

NOTE

- The images have been calibrated before leaving the factory and can be used directly. If the highest temperature detection points are deviating on the visible light image, it needs to be re-calibrated.

Operation Procedure

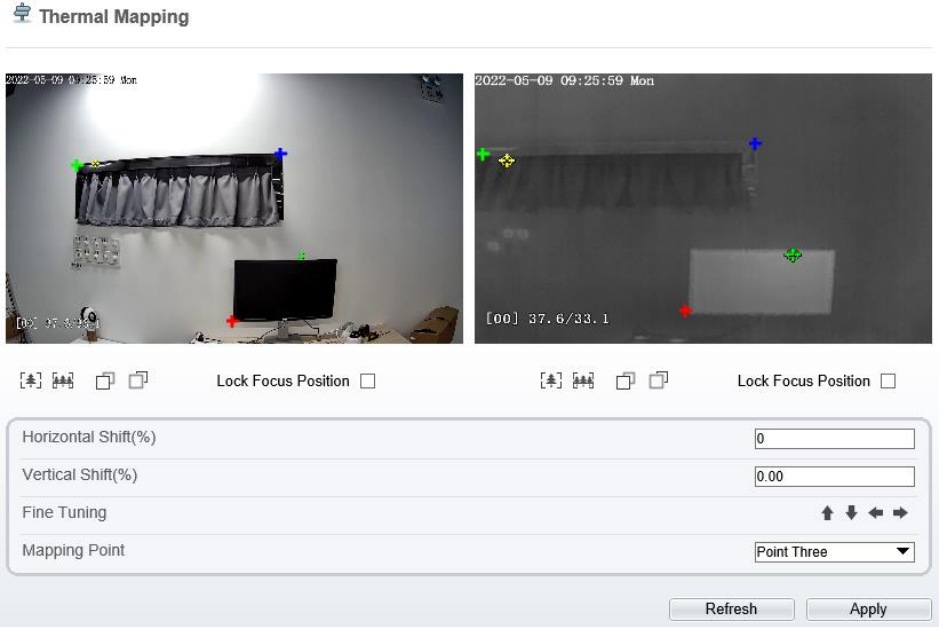

Step 1 Choose **Configuration > Temperature Measurement > Thermal Mapping**, as shown in Figure 3-14.

Figure 3-14 Thermal mapping interface



Step 2 Settings please refer to Table 3-8.

Table 3-8 Parameter of thermal mapping

Parameter	Description	Setting
	Zoom in /zoom out.	[Setting method] Click the button
	Near focus / far focus.	[Setting method] Click the button
Lock focus position	N/A	[Setting method] Tick .
Horizontal shift(%)	Adjust horizontal position of area which is on visual image.	[Setting method] Input value
Vertical shift(%)	Adjust vertical position of area which is on visual image.	[Setting method] Input value
Fine turning	Click the icon to adjust the position trifle.	[Setting method] Click

Parameter	Description	Setting
Mapping point	You need map three points at two channels. Points are correspond of each. The three points should cover most areas, and two points are located in the diagonal display of the picture. Point one is green cross. Point two is red cross. Point three is blue cross.	[Setting method] Select from drop list .

Step 3 Click **Apply**. The message "**Apply success**" is displayed, the system saves the settings.

----End

3.7 Bad Point Check

Operation Procedure

Step 1 Choose **Configuration >Thermal > Bad Point Check**.

The **Bad Point Check** page is displayed, as shown in Figure 3-15.

If the image has a white dot as shown in figure, user can test the function to recover the bad point. User should connect the technical support at this condition to make sure to apply.

Figure 3-15 Bad point check



Step 2 Click the white point at image, click **Reset** to recover the bad point, as shown in Figure 3-16.

Figure 3-16 Recover bad point



Step 3 Click **Apply**. The message "Apply success" is displayed, the system saves the settings.

----End

3.8 LED Control Param

Set the display mode and brightness of LED, as shown in Figure 3-17.

Figure 3-17 LED control param

 Led Control Param

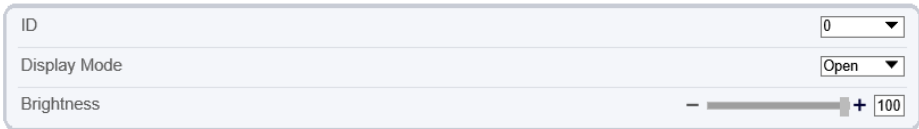

Refresh

Apply

Table 3-9 LED control param

Parameter	Description	Setting
Display Mode	There are five modes can be chosen. Open: the LED is always lighting. Close: the LED is closed. Flicker: set the flicker interval, the LED will flicker as the set. Timing: the LED will lighting at the set time. Mode 5: linkages alarm, when the flash linkage alarm is triggered, the LED light is always on for 15 seconds.	[Setting method] Select from drop-down list.
Brightness	The LDE's brightness	[Setting method] Drag the slider. [Default value] 100

----End

3.9 Digital Tube

Set the digital tube parameters, as shown in Figure 3-18.

Figure 3-18 Digital tube

 Digital Tube

Enable ON

Relate Area ID

Table 3-10 Digital tube

Parameter	Description	Setting
Enable	Enable it, the digital tube will show the temperature of detecting.	[Default value] Enable
Relate Area ID	It is relativity to the Area ID of Parameter Configure , choose one ID, the tube will show the highest temperature of that area.	[Setting method] Select from drop-down list . [Default value] 1

----End

4 Visible Sensor Configuration

4.1 Accessing the Sensor Interface

Procedure

Step 1 On the web, move the cursor to the real-time video page and right-click on the page. A shortcut menu is displayed, as shown in Figure 4-1

Figure 4-1 Sensor setting interface

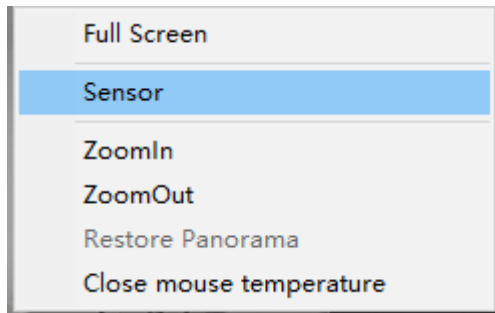

Or at “**Configuration > Sensor Setting**” interface to set, as shown in Figure 4-2.

Figure 4-2 Sensor setting

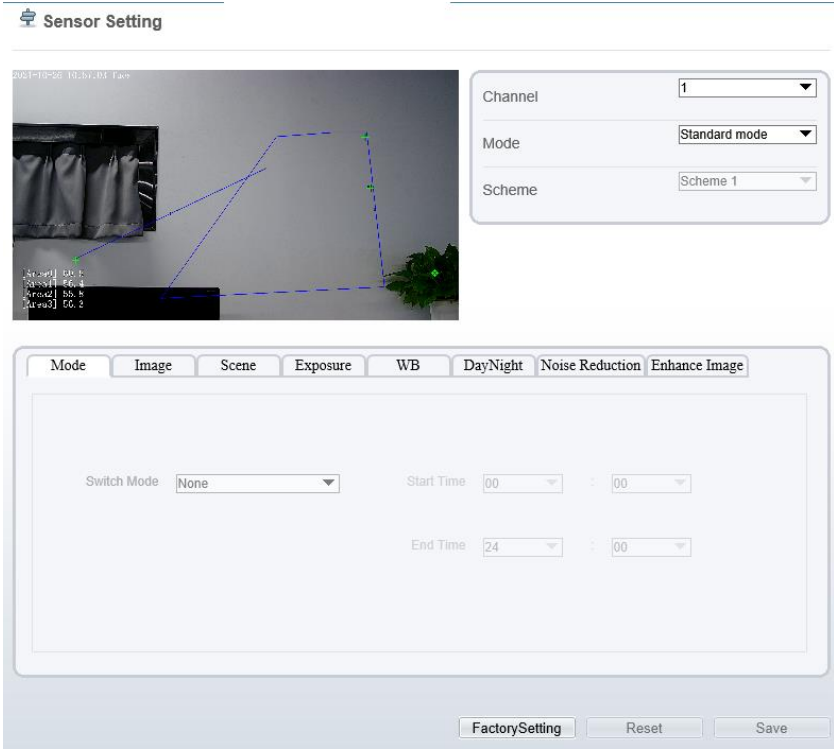

Step 2 Choose **Sensor Configure** and the **Sensor Setting** dialog box appears.

NOTE

- All sensor configure can be modified at debug mode. Click **Standard** in the lower left corner of Sensor Setting, and choose **Debug Mode**.

----End

4.2 Mode

Step 3 Click **Standard** in the lower left corner of Sensor Setting, and choose **Debug Mode**.
As shown in Figure 4-3.

Figure 4-3 Mode

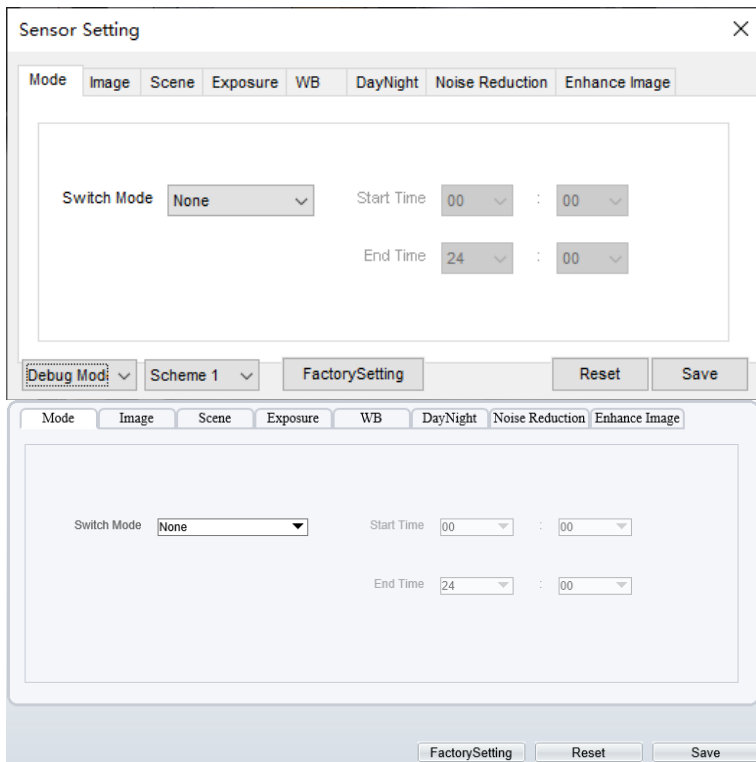

Step 4 Choose the switch mode from the drop-down list.

Step 5 Time mode: Set the Start Time, set the End Time.

Step 6 Click **Save**, the message "**Save succeed**" is displayed, the system saves the settings.

----End

4.3 Image Adjust

Figure 4-4 shows the Image Adjust tab page.

Figure 4-4 Image

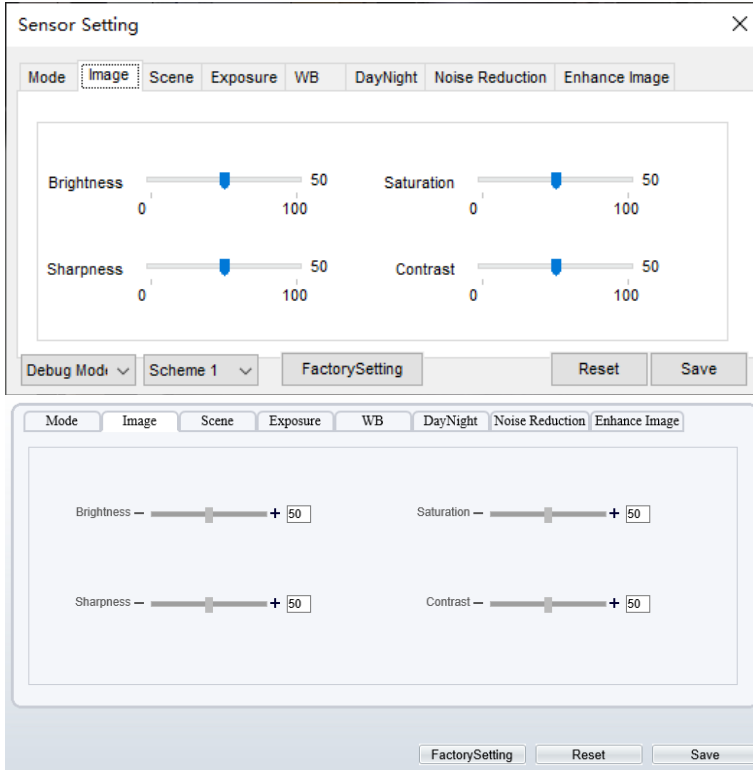

Table 4-1 describes the parameters on the Image Adjust tab page.

Table 4-1 Parameters of image

Parameter	Description	Configuration Method
Brightness	It indicates the total brightness of an image. As the value increases, the image becomes brighter.	[Setting method] Drag the slider. [Default value] 50
Sharpness	It indicates the border sharpness of an image. As the value increases, the borders become clearer, and the number of noise points increases.	[Setting method] Drag the slider. [Default value] 50

Saturation	It indicates the color saturation of an image. As the value increases, the image becomes more colorful.	[Setting method] Drag the slider. [Default value] 50
Contrast	It indicates the measurement of different brightness levels between the brightest white and darkest black in an image. The larger the difference range is, the greater the contrast; the smaller the difference range is, the smaller the contrast	[Setting method] Drag the slider. [Default value] 50

----End

4.4 Scene

Figure 4-5 shows the scene tab page.

Figure 4-5 Scene

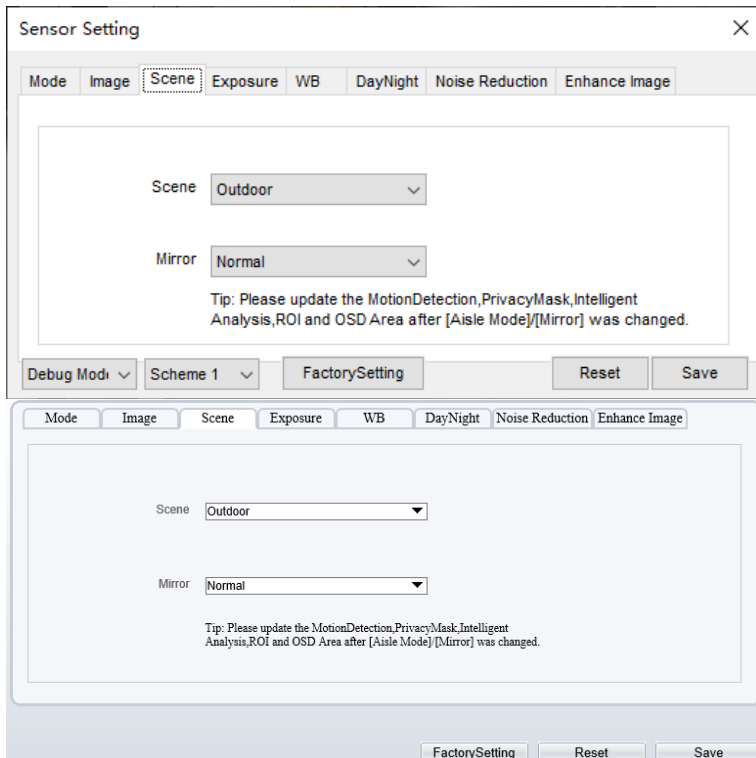

Table 4-2 describes the parameters on the scene tab page.

Table 4-2 Parameters of scene

Parameter	Description	Configuration Method
Scene	Indoor or outdoor.	[Setting method] Select a value from the drop-down list. [Default value] Indoor
Mirror	It is used to select the pixel location of an image. <ul style="list-style-type: none">• Normal: The image does not flip.• Horizontal: The image flips to the left and right.• Vertical: The image flips up and down.• Horizontal+ Vertical: The image rotates at 180 degrees.	[Setting method] Select a value from the drop-down list. [Default value] Normal

----End

4.5 Exposure

Figure 4-6 shows the Exposure tab page.

Figure 4-6 Exposure

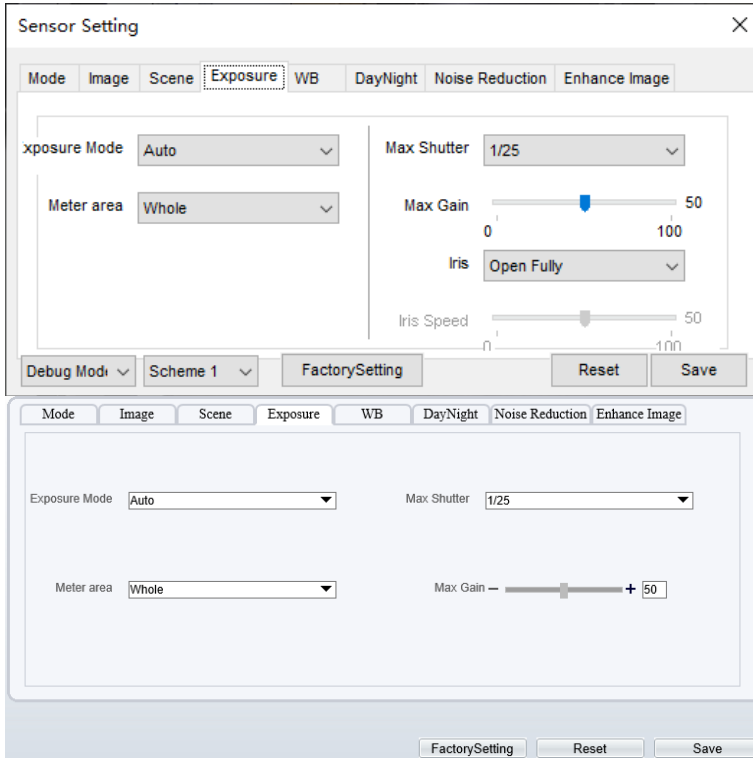

Table 4-3 describes the parameters on the Exposure setting tab page.

Table 4-3 Parameters of exposure setting

Parameter	Description	Configuration Method
Exposure Mode	<p>The exposure modes include:</p> <ul style="list-style-type: none"> • Auto: The system performs auto exposure based on the monitoring environment. • Manual: You can set Shutter Setting to fixed values manually. • Shutter Priority: You can set Shutter Setting to fixed values. The shutter and gain are automatically adjusted by the system. 	<p>[Setting method] Select a value from the drop-down list. [Default value] Auto</p>

Meter area	Choose the area to meter, there are whole, center spot, and center area.	[Setting method] Select a value from the drop-down list. [Default value] Whole
Max Shutter	It is valid in Iris Priority mode. You can select a maximum shutter speed. As the value increases, the image becomes brighter.	[Setting method] Select a value from the drop-down list. [Default value] 1/25
Max gain	It indicates the maximum gain. The device automatically adjusts the gain based on the external light, and the gain is less than or equal to the value of this parameter.	[Setting method] Drag the slider. [Default value] 50

----End

4.6 WB

Figure 4-7 shows the WB tab page.

Figure 4-7 WB

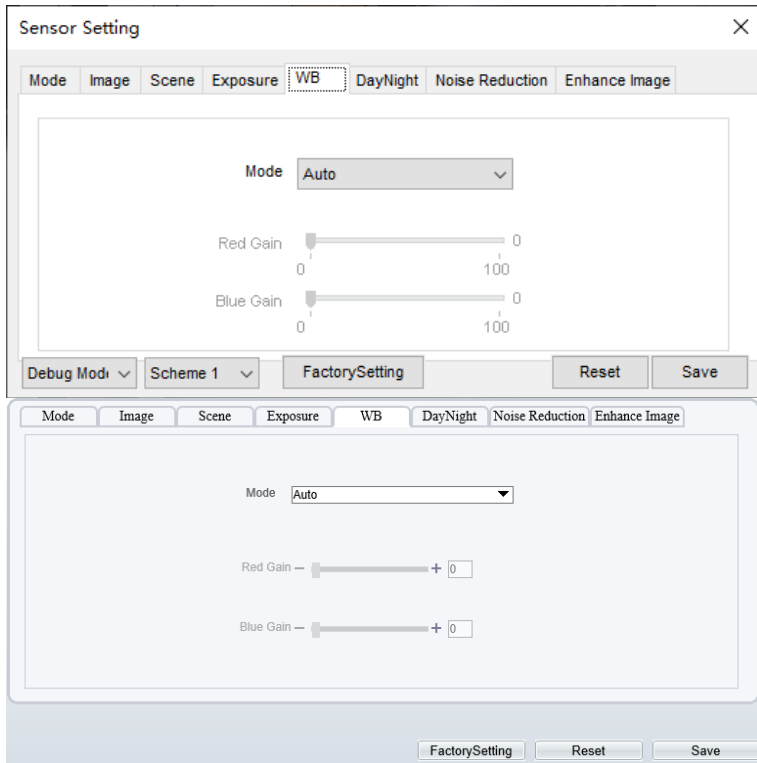

Table 4-4 describes the parameters on the WB tab page.

Table 4-4 Parameters of WB

Parameter	Description	Configuration Method
Mode	<p>It is used to display the real color of a monitoring scenario when the color temperature changes.</p> <ul style="list-style-type: none"> • Auto: camera adjusts automatically. • Tungsten: at Tungsten lamp Environment. • Fluorescent: fluorescent environment. • Daylight: at daylight environment. • Shadow: at low light environment. • Manual: adjust red and blue gain manually. 	<p>[Setting method] Select a value from the drop-down list. [Default value] Auto</p>

----End

4.7 DayNight

Figure 4-8 shows the day-night tab page.

Figure 4-8 Day-night

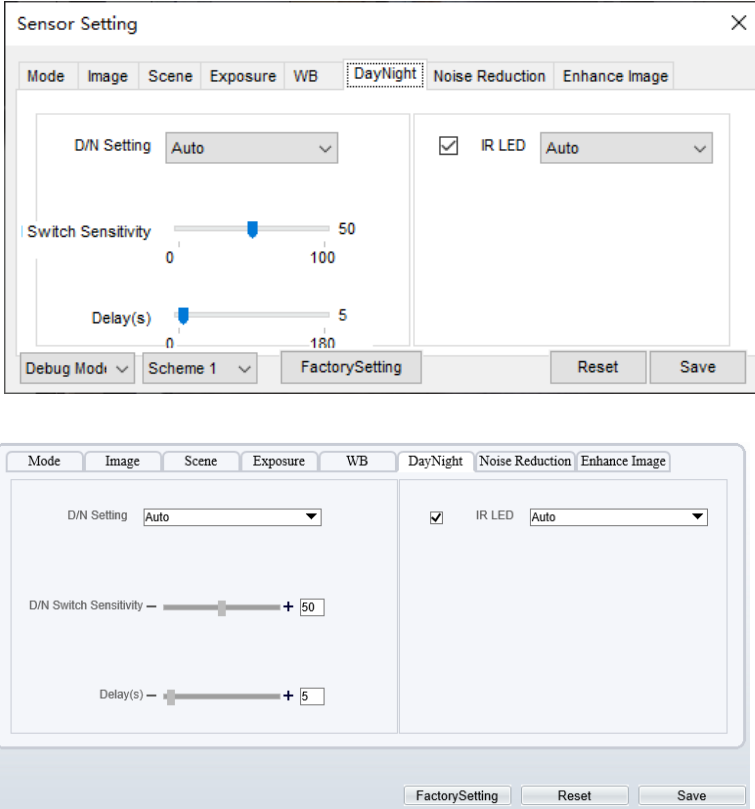

Table 4-5 describes the parameters on the Special Function tab page.

Table 4-5 Parameters of day night

Parameter	Description	Configuration Method
DayNight Mode	<p>It can be set to Auto, Day Mode, Night Mode and Timing.</p> <ul style="list-style-type: none"> • Auto mode The image color is adjusted based on the day/night mode. In auto mode, the image switches between the colored state and the black and white state based on the brightness. In day mode, the image is colored. In night mode, the image is black and white. • Day mode The image is colored, and the filter is in the day state, preventing infrared light from entering the sensor. • Night mode The image is black and white, and the filter is in the night state, allowing all types of light to enter the sensor. • Timing Select time from the drop-down list by the “Day To Night Time” and “Night To Day Time”. 	<p>[Setting method] Select a value from the drop-down list. [Default value] Day Mode</p>
Trans (D to N)	Day transit to night.	<p>[Setting method] Drag the slider. [Default value] 50</p>
Trans (N to D)	Night transit to day.	<p>[Setting method] Drag the slider. [Default value] 50</p>
Delay	N/A	<p>[Setting method] Drag the slider. [Default value] 5</p>

----End

4.8 Noise Reduction

Figure 4-9 shows the noise reduction tab page.

Figure 4-9 Noise reduction

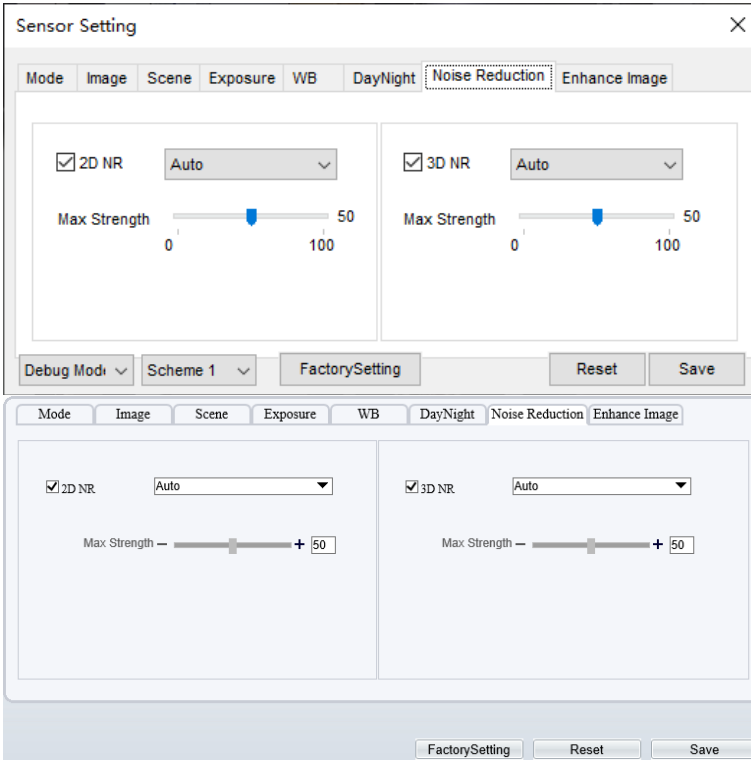

Table 4-6 describes the parameters on the Special Function tab page.

Table 4-6 Parameters of noise reduction

Parameter	Description	Configuration Method
2D NR	Auto /manual, default value is auto. By comparing and screening the images of the two frames before and after, the noise point position is found out and gain control is carried out on them.	[Setting method] Drag the slider strength. [Default value] Auto / 50

3D NR	Auto /manual, default value is auto. The 3D digital noise reduction function can reduce the noise interference of the weak signal image.	[Setting method] Drag the slider of strength. [Default value] Auto / 50
-------	---	---

----End

4.9 Enhance Image

Figure 4-10 shows the enhance image Setting tab page.

Figure 4-10 Enhance image

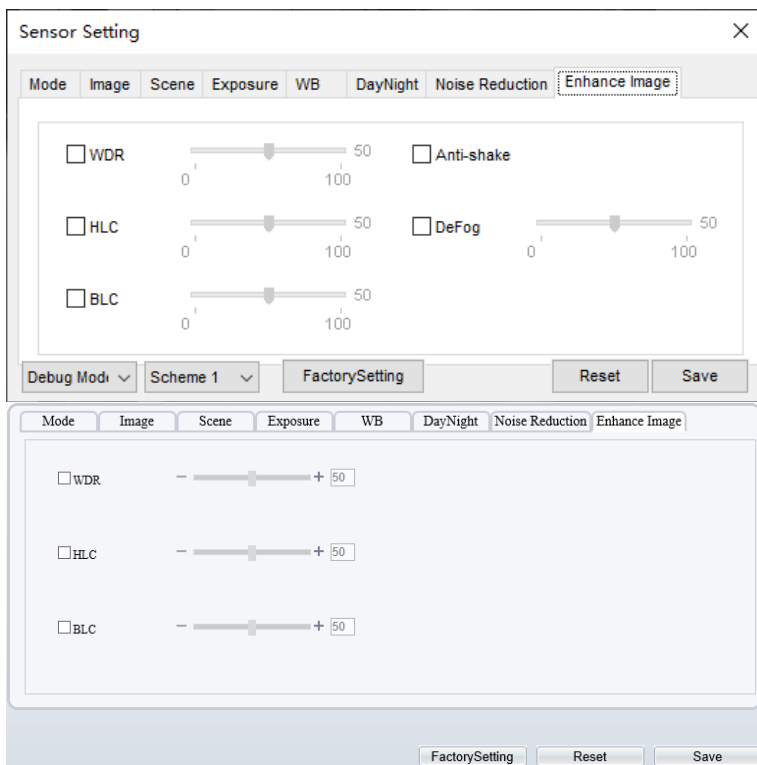



Table 4-7 describes the parameters on the enhance image setting tab page.

Table 4-7 Parameters of enhance image

Parameter	Description	Configuration Method
WDR	It is intended to provide clear image performance in strong backlight areas such as exterior light coming through a window or glass door. High contract light conditions are no longer a problem when you need to capture detailed images.	[Setting method] Drag the slider. [Default value] 50
HLC	It indicates reverse bright points in the picture to black. As an effective approach to recognize vehicle plate number at night, HLC function can detect any spotlight diffused by object-vehicle and compensate it for obtaining clearer image.	[Setting method] Drag the slider. [Default value] 50
BLC	It indicates Back Light Compensation (BLC) automatically brings more detail to darker areas of an image when bright light shining from behind obscures it and provides perfect exposure for an object in front of very strong back light. The electronic shutter of the camera basically adjusts its exposure to try to allow for more light to be allowed in the darker areas.  NOTE This parameter applies only to visible light.	[Setting method] Drag the slider. [Default value] 50
Anti-shake	When the camera shakes out, it is processed by algorithm compensation	[Default value] Disable
Defog	It indicates the camera defog automatically.	[Setting method] Drag the slider. [Default value] 50

----End

5 Thermal Sensor Configuration

5.1 Accessing the Sensor Interface

Operation Procedure

Step 7 On the Internet Explorer interface or the client software interface, choose channel 2 select and right-click the surveillance image to the set, as shown in Figure 5-1.

Figure 5-1 Sensor configuration

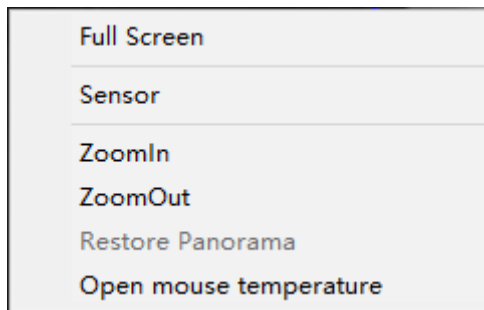

Or at “**Configuration** > **Sensor Setting**” interface to set, as shown in Figure 5-2.

Figure 5-2 Thermal channel sensor setting

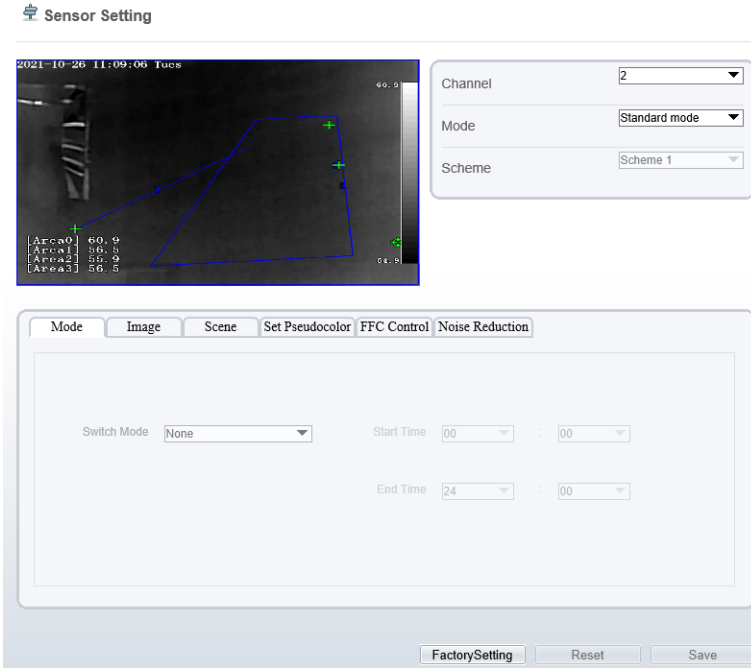

Step 8 Choose **Sensor**. The **Sensor Configuration** dialog box is displayed, as shown in Figure 5-3.

----End

5.2 Mode

Figure 5-3 shows the Mode interface.

Figure 5-3 Mode interface

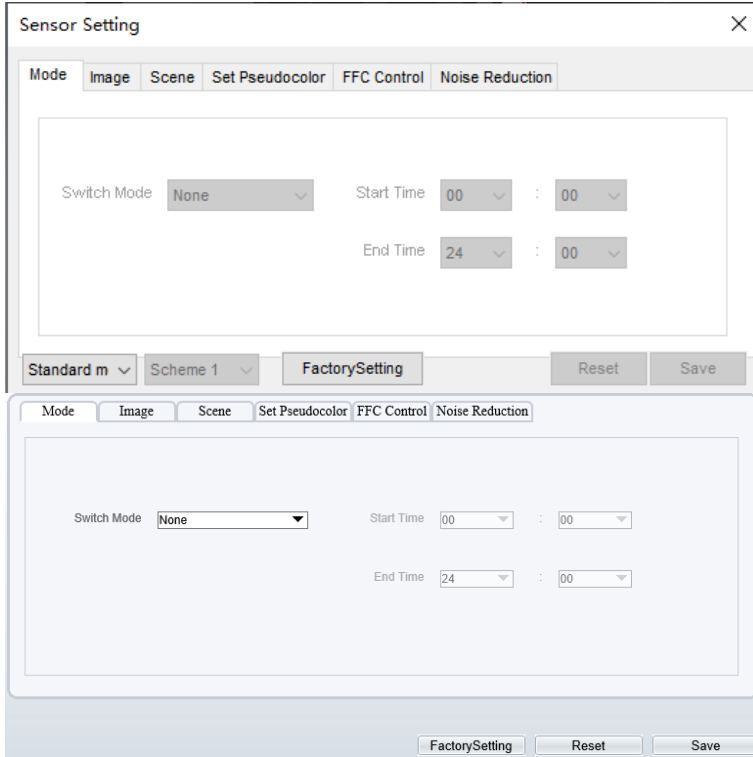

Operation Procedure

- Step 1 Click **Standard** in the lower left corner of Sensor Setting, and choose Debug Mode.
- Step 2 Choose switch mode from the drop-down list.
- Step 3 Time mode: Set the Start Time, set the End Time.
- Step 4 Click Save, the message "Save succeed" is displayed, the system saves the settings.

----End

5.3 Images

Figure 5-4 shows the **Image** setting interface.

Figure 5-4 Image setting interface

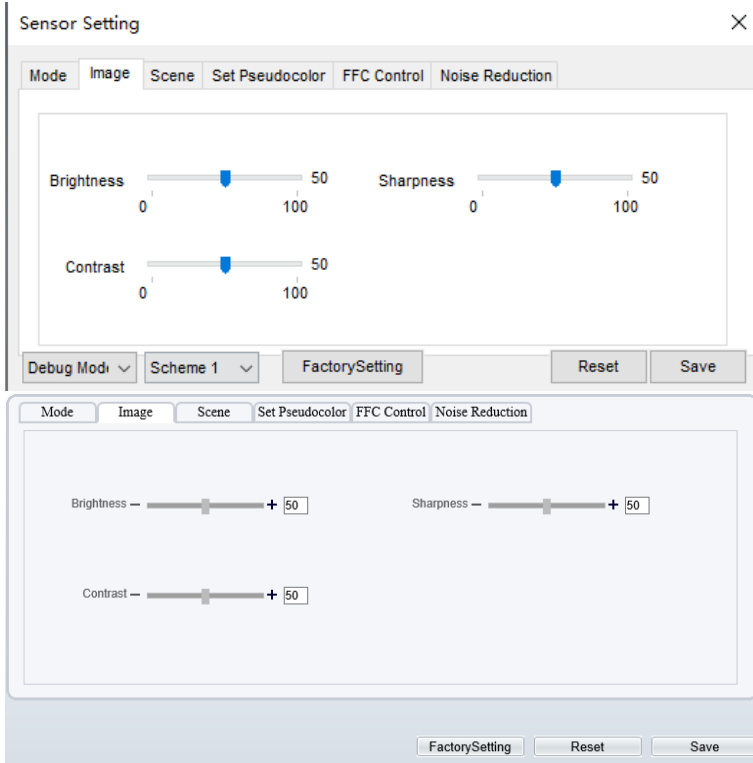

- Step 1 Click **Standard** in the lower left corner of Sensor Setting, and choose Debug Mode.
- Step 2 Drag the slider to adjust parameter of image.
- Step 3 Click Save, the message "Save succeed" is displayed, the system saves the settings.

NOTE

- Brightness :It indicates the total brightness of an image. As the value increases, the image becomes brighter. It ranges from 0 to 100.
- Contrast : It indicates the contrast between the bright part and the dark part of an image. As the value increases, the contrast increases. It ranges from 0 to 100.
- Sharpness: it indicates the contrast between definition and edge sharpness. The higher value, the higher definition and greater distortion. It ranges from 0 to 100

----End

5.4 Scene

Figure 5-5 shows the **Scene** setting interface.

Figure 5-5 Scene setting interface

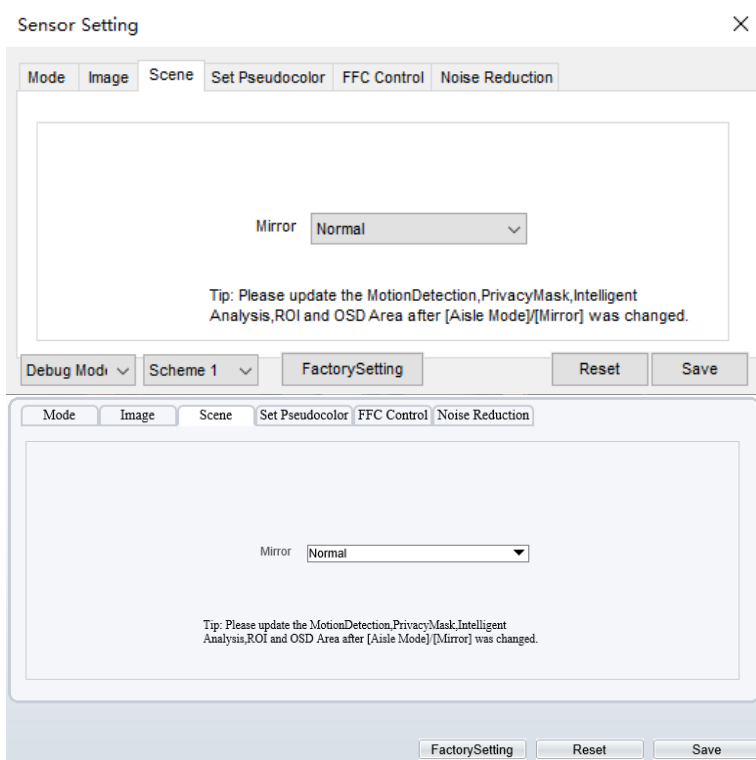

Step 1 Click **Standard** in the lower left corner of Sensor Setting, and choose scene

Step 2 Choose mirror mode from drop-list.

Step 3 Click Save, the message "Save succeed" is displayed, the system saves the settings.



NOTE

- Mirror providing the selection of image pixel locations.
- Normal: the image is not flipped.
- Horizontal: the image is flipped left and right.
- Vertical: the image is flipped up and down.
- Horizontal + Vertical: the image is rotated at 180 degree.

----End

5.5 Set Pseudocolor

Figure 5-6 shows the **Set pseudocolor** setting interface.

Figure 5-6 Set pseudocolor setting interface

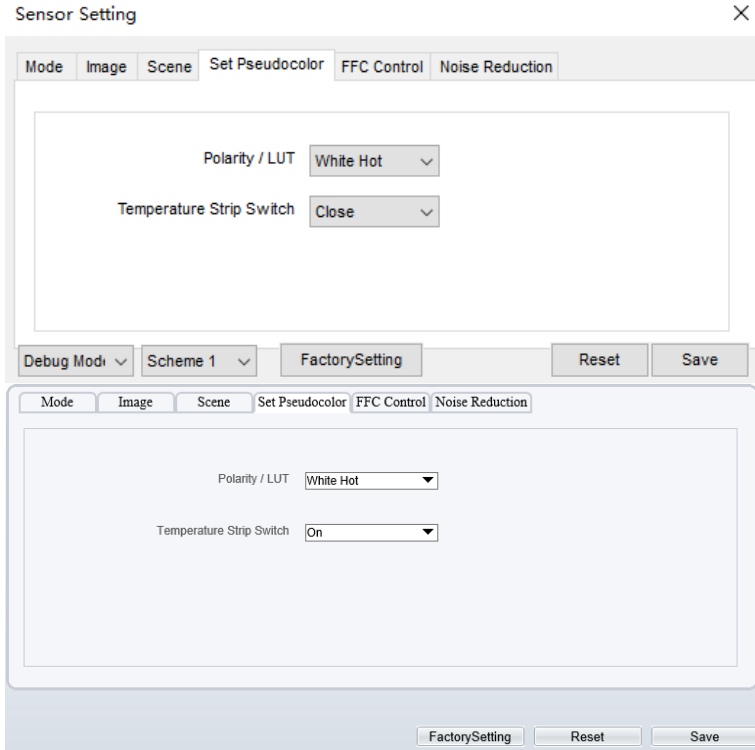

- Step 1 Click **Standard** in the lower left corner of Sensor Setting, and choose set pseudo color
- Step 2 Choose polarity/LUT mode from drop-list.
- Step 3 Enable or disable the temperature strip switch.
- Step 4 Click Save, the message "Save succeed" is displayed, the system saves the settings.

 **NOTE**

- The temperatures of the temperature fields detected by the thermal imaging camera are separately mapped to values ranging from 0 to 255 by the algorithm. In the black/white display mode, this range is converted to the gray scale tones. For example, 0 indicates completely black, and 255 indicates completely white. The temperature field of the scene is converted to images by using the grayscale ranging from 0 to 255. Different polarity modes can be converted to different display images. The most common setting is white hot (a hotter object is displayed brighter than a colder object) or black hot (a hotter object is displayed darker than a colder object). The difference between two modes lies in that the temperatures corresponding to the darker one and the lighter one are reversed. Other modes include rainbow, ironbow, HSV, autumn, bone and so on.

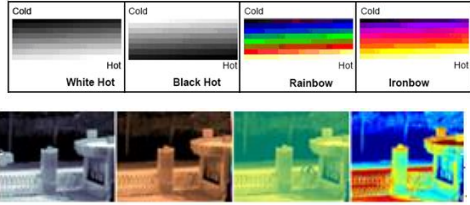

5.6 FFC Control

Figure 5-7 shows the **FFC control** interface.

Figure 5-7 FFC control interface

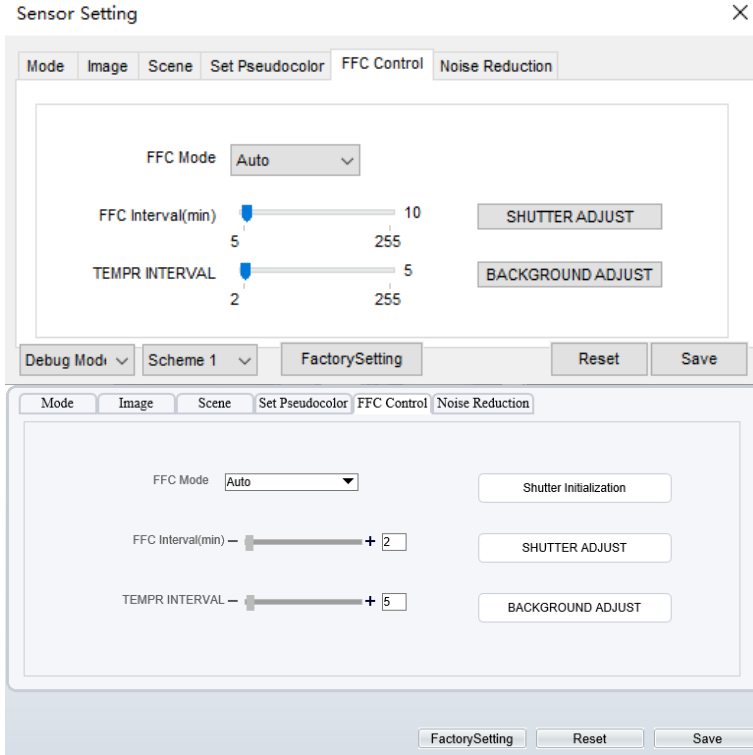

Table 5-1 lists the parameters on the FFC control interface.

Table 5-1 Parameters of FFC control interface

Parameter	Description	Setting
FFC Mode	The internal of the thermal imaging camera may comprise the mechanical action correction mechanism that can periodically improve the image quality. This component is called flat field correction (FFC). When controlling the FFC, the FFC shields the sensor array, so that each portion of the sensor can collect uniform temperature fields (flat field). By means of FFC, the camera can update the correction coefficients to output more uniform images. Throughout the FFC process, the video image is frozen for two seconds and a static-frame image is displayed. After the FFC is complete, the image is automatically recovered. Repeated FFC operations can prevent the grainy and image	[How to set] Select from the drop-down list box. [Default value] Auto

Parameter	Description	Setting
	<p>degradation problems. The FFC is especially important when the temperature of the camera changes. For example, after the camera is powered on or the ambient temperature is changed, you should immediately perform the FFC.</p> <p>Auto: In the Automatic FFC mode, the camera performs FFC whenever its temperature changes by a specified amount or at the end of a specified period of time (whichever comes first). When this mode is selected, the FFC interval (minutes) ranges from 5 to 30 minutes. The temperature change of the camera is based on the temperatures collected by the internal temperature probe. The temperature of the camera sharply changes when the camera is powered on. The FFC is relatively frequent, which is normal.</p> <p>Manual: In the manual FFC mode, the camera does not automatically perform the FFC based on the temperature change or the specified period. You can press the Do FFC button to select the manual FFC mode. When you feel that the image is obviously degraded but the automatic FFC is not performed, you can use the manual FFC function to check whether the image quality can be improved.</p>	
FFC interval (min)	In the automatic FFC mode, the FFC interval ranges from 10 to 255 minutes. When the time reach to setting value, the camera does shutter adjust operation automatically.	[How to set] Select by dragging the slider. [Default value] 15
Tempr interval	In the automatic FFC mode, the tempr interval value ranges from 5 to 255 degree centigrade. When the time reach to setting value, the camera does background adjust operation automatically.	[How to set] Select by dragging the slider. [Default value] 5
Shutter initialization	Click the icon and shutter will be initialized	Manually
Shutter adjust	Click the icon and camera perform the action.	Manually

Parameter	Description	Setting
Background adjust	Click the icon and camera perform the action.	Manually

----End

5.7 Noise Reduction

Figure 5-8 shows the **Noise reduction** interface.

Figure 5-8 Noise reduction interface

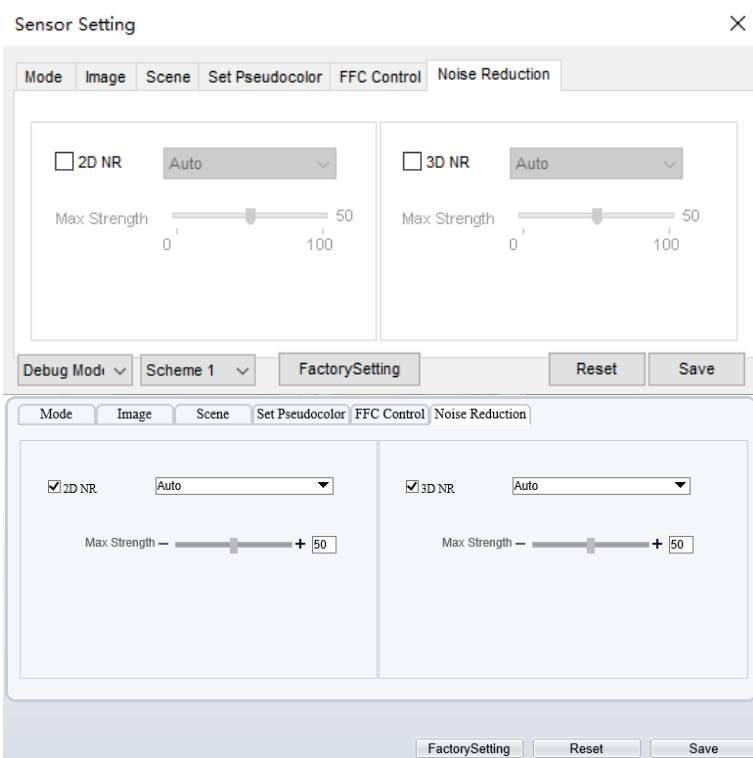

Table 5-2 lists the Noise reduction parameters.

Table 5-2 Parameters of noise reduction interface

Parameter	Description	Setting
2DNR	Decrease the image noise.	[How to set] Select from the drop-down list box.

Parameter	Description	Setting
		[Default value] Close
3DNR	Decrease the image noise.	[How to set] Select from the drop-down list box. [Default value] Close

----End

6 Intelligent Analysis

There are many kinds of intelligent analysis, such as perimeter, single virtual fence, double virtual fences, multi loiter, converse, personnel count, enter area, leave area. The parameters of these analysis alarm are roughly similar, so we will describe someone in detail as reference.

6.1 Perimeter

Description

The perimeter function refers to that an alarm is generated when the targets of specified types (such as person, car, and both person and car) enter the deployment area.

Procedure

Step 1 Select **Configuration > Intelligent Analysis > Perimeter** to access the **Perimeter** interface, as shown in Figure 6-1.

Figure 6-1 Perimeter setting interface

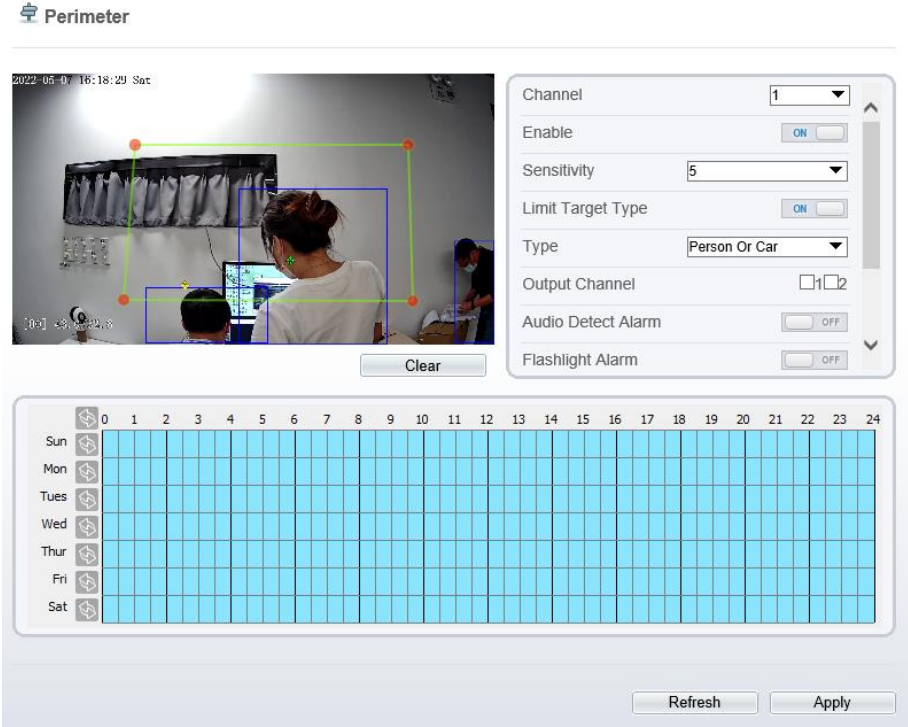

Step 2 Set all parameters for perimeter. Table 6-1 describes the specific parameters.

Table 6-1 Parameter perimeter parameter description

Parameter	Description	Setting
Channel	Channel 1: visible light. Channel 2: thermal.	Choose one channel to set.
Enable	Enable the button to enable the alarm.	[How to set] Click Enable to enable. [Default value] OFF
Sensitivity	The sensitivity of detecting the target, when the value is high, the target can be detected easily, but the accuracy will be lower.	[How to set] Choose from the drop-down list [Default value] 5

Parameter	Description	Setting
Limit Target Type	Effective alarms are set based on target type, with options of Person or Car, person, car. When the device is used indoors, because of small space and large targets, to avoid wrong alarms are triggered by persons even if car is selected, it is recommended to set the target type to person for indoor use.	[How to set] Click to enable Limit Target Type. [Default value] OFF
Output Channel	If you check to set the Output Channel and the device is connected to an external alarm indicator, the alarm indicator signals when an alarm is triggered.	[How to set] Click to select an ID.
Audio detection alarm	Enable, when happen the alarm, it will be play audio to alarm. Choose the sound alarm file (set at the “ Configuration > Alarm > Sound Alarm Output ”).	[How to set] Click to enable Audio Detection Alarm [Default value] OFF
Flashlight alarm	Enable, when it is triggered alarm, it flashes the light. But when users set the display mode to Mode 5 at “ Configuration > Thermal > Led Control Param ”interface, the lighth will be always on for 15s, not flash when it is alarm.	[How to set] Click to enable Flashlight Alarm. [Default value] OFF
Alarm Record	If you install SD card, enable this function, the device will record the alarm video.	[How to set] Click to enable Alarm Record. [Default value] OFF
SMTP	Enable the button to enable SMTP serve.	[How to set] Click to enable SMTP. [Default value] OFF
FTP Upload	Enable the button to enable File Transfer Protocol.	[How to set] Click to enable FTP Upload. [Default value] OFF

Parameter	Description	Setting
Video Stream Draw Line	Enable the button to enable Video Stream Draw Line, the setting area frame will show on live video.	[How to set] Click to enable Video Stream Draw Line. [Default value] OFF

Step 3 Set a deployment area. Move the cursor to the drawing interface and click to generate a point, move the cursor to draw a line, and then click to generate another point. This is how a line is generated. In this way, continue to draw lines to form any shape, and right-click to finish line drawing.



NOTE

- A drawn line cannot cross another one, or the line drawing fails.
- Any shape with 8 sides at most can be drawn.
- The quantity of deployment areas is not limited yet and will be described in future when a limit is applied.

Step 4 Set deployment time.

Method 1: Click left mouse button to select any time point within 0:00-24:00 from Monday to Sunday as shown in Figure 6-2.

Method 2: Hold down the left mouse button, drag and release mouse to select the deployment time within 0:00-24:00 from Monday to Sunday.

Method 3: Click  in the deployment time page to select the whole day or whole week.



NOTE

- When you select time by dragging the cursor, the cursor cannot be moved out of the time area. Otherwise, no time can be selected.

Deleting deployment time: Click  again or inverse selection to delete the selected deployment time.

Figure 6-2 Deployment time setting interface



---End

6.2 Single Virtual Fence

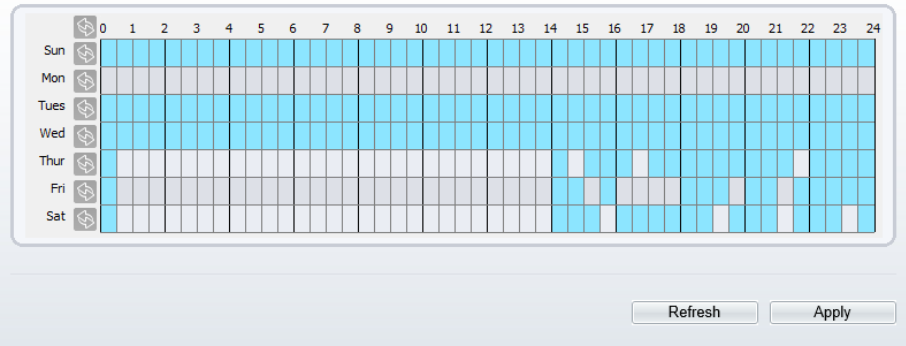
Description

A single virtual fence is a line that is set at a concerned position within the monitored field of view and specifies the forbidden travel direction; An alarm is generated when the targets of specified types (such as person or car) cross this line.

Procedure

- Step 1 Select **Configuration > Intelligent Analysis > Single Virtual Fence** to access the **Single Virtual Fence** setting interface, as shown in Figure 6-3.

Figure 6-3 Single virtual fence setting interface

Single Virtual Fence

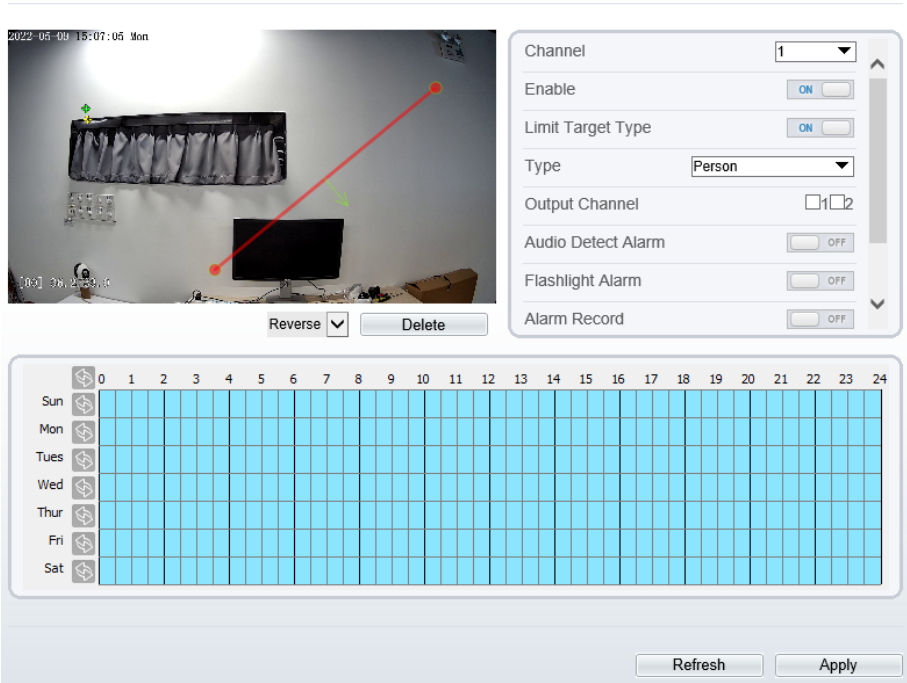

Step 2 Set all parameters for the single virtual fence. Table 6-2 describes the specific parameters.

Table 6-2 Parameters of single virtual fence

Parameter	Description	Setting
Channel	Channel 1: visible. Channel 2: thermal.	[How to set] Choose one channel to set.
Enable	Enable the button to enable the alarm.	[How to set] Click Enable to enable. [Default value] OFF

Parameter	Description	Setting
Limit Target Type	Effective alarms are set based on target type, with options of Person or Car, person, car. When the device is used indoors, because of small space and large targets, alarms are triggered by person sometimes even if car is selected, leading to false alarms. It is recommended to set the target type to person for indoor use.	[How to set] Click to enable Limit Target Type. [Default value] OFF
Output Channel	If you check to set the Output Channel and the device is connected to an external alarm indicator, the alarm indicator signals when an alarm is triggered.	[How to set] Click to select an ID.
Audio detection alarm	Enable, when happen the alarm, it will be play audio to alarm. Choose the sound alarm file (set at the “ Configuration > Alarm > Sound Alarm Output ”).	[How to set] Click to enable Audio Detection Alarm [Default value] OFF
Flashlight alarm	Enable, when it is triggered alarm, it flashes the light. But when users set the display mode to Mode 5 at “ Configuration > Thermal > Led Control Param ”interface, the lighth will be always on for 15s, not flash when it is alarm.	[How to set] Click to enable Flashlight Alarm. [Default value] OFF
Alarm Record	If you install SD card, enable this function, the device will record the alarm video.	[How to set] Click to enable Alarm Record. [Default value] OFF
SMTP	Enable the button to enable SMTP sever.	[How to set] Click to enable SMTP. [Default value] OFF

Parameter	Description	Setting
FTP Upload	Enable the button to enable File Transfer Protocol.	[How to set] Click to enable FTP. [Default value] OFF
Video Stream Draw Line	Enable the button to enable Video Stream Draw Line, the setting area frame will show on live video.	[How to set] Click to enable Video Stream Draw Line. [Default value] OFF

Step 3 Set a deployment area:

Draw a line: move the cursor to the drawing interface, hold down the left mouse button, and move the cursor to draw a line. When you release the left mouse button, a single virtual fence is generated.

Setting a single virtual fence: Click a line (and the trip line turns red) to select the single virtual fence and set its direction as Positive, Reverse or Bidirectional, or delete the selected line. You can also press and hold left mouse button at the endpoint of a single virtual fence and move the mouse to modify the position and length of this single virtual fence. You can right-click to delete the single virtual fence.



NOTE

- A single virtual fence is not within any deployment area, therefore, when an alarm is generated, the trace always exists. Only when the target object moves out of the field of view, the trace disappears.
- Try to draw the single virtual fence in the middle, because the recognition of a target takes time after target appearance on the screen and an alarm is generated only when the object is recognized to have crossed the single virtual fence.
- The single virtual fence which detects person foot as the recognition target cannot be too short, because a short single virtual fence tends to miss targets.

Step 4 Set deployment time.

----End

6.3 Double Virtual Fences

Description

Double virtual fences refer to two lines that are set at a concerned special position within the field of view and specify the forbidden travel direction. When the targets of specified types (such as person or car) move along the set travel direction and cross these lines in a certain order (line 1 followed by line 2) in pass max time, an alarm is generated.

Procedure

Step 1 Select **Configuration > Intelligent Analysis > Double Virtual Fences** to access the **Double Virtual Fences** setting interface, as shown in Figure 6-4.

Figure 6-4 Double virtual fences setting interface

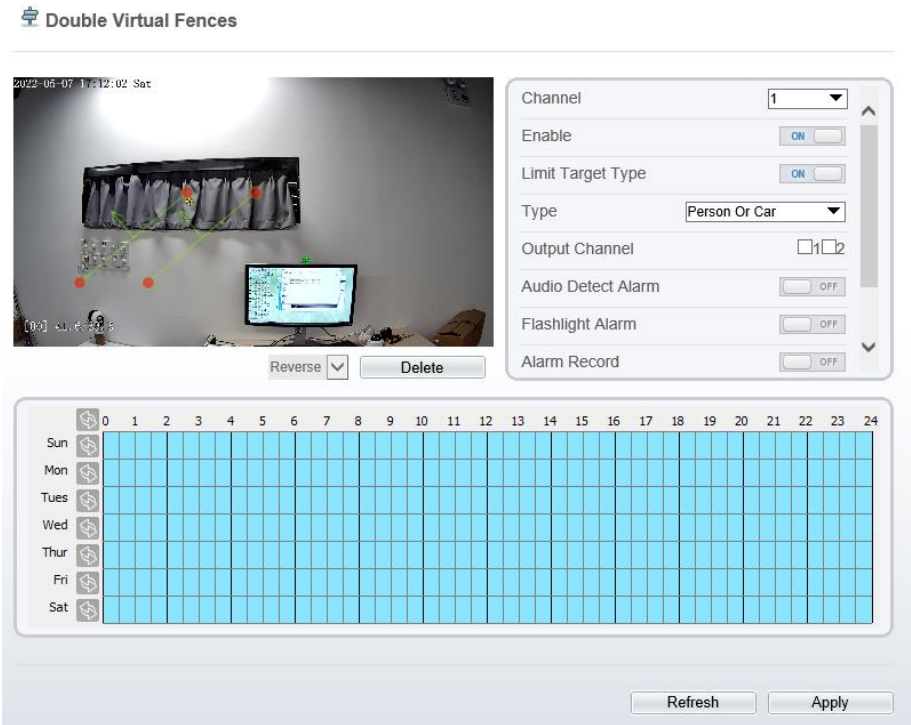

Step 2 Set all parameters for the double virtual fences. The details please refer to Table 6-2

Step 3 Set a deployment area.

Draw a line: move the cursor to the drawing interface, hold down the left mouse button, and move the cursor to draw two lines. When you release the left mouse button, two

numbered virtual fences are generated. Choose either of the double virtual fences to set the direction to Positive or Reverse.

Set double virtual fences: Click one of the double virtual fences (and the virtual fence turns red) to select this virtual fence and set the direction to **Positive** or **Reverse**, or delete the selected line. You can also press and hold left mouse button at the endpoint of a virtual fence and move the mouse to modify the position and length of this virtual fence. You can right-click to delete the double virtual fences.



NOTE

- The two virtual fences are in sequential order. An alarm is generated only when a target crosses virtual fence 1 and then virtual fence 2 within the set maximum passing time.
- The double virtual fences are not within any deployment area, therefore, when an alarm is generated, the trace always exists. Only when the target object moves out of the field of view, the trace disappears.
- Try to draw double virtual fences in the middle, because the recognition of a target takes time after target appearance on the screen and an alarm is generated only when the object is recognized to have crossed the double virtual fences.
- The double virtual fences which detect person foot as the recognition target cannot be too short, because short double virtual fences tend to miss targets.

Step 4 Set deployment time.

----End

6.4 Personnel Count

Description

User can draw line to count the personnel at the special area.

Procedure

Step 1 Select **Intelligent Analysis > Personnel Count** to access the **Personnel Count** setting interface, as shown in Figure 6-5.

Figure 6-5 Personnel count

Personnel Count

Channel: 1

Enable: ON

OSD Enable: ON

Counting Clear Interval: 1Day

Clear Counting

Area Type: Line

A->B: Out

B->A: In

Clear

	0	1	2	3	4	5	6	7	8	9	10	11	12	13	14	15	16	17	18	19	20	21	22	23	24
Sun																									
Mon																									
Tues																									
Wed																									
Thur																									
Fri																									
Sat																									

Refresh Apply

Set Correction Value: OFF

Over People Number Alarm: OFF

Alarm Threshold: 1000

Output Channel: 1 2

Audio Detect Alarm: OFF

Flashlight Alarm: OFF

Alarm Record: OFF

SMTP: OFF

Step 2 Set all parameters for illegal parking. Table 6-3 describes the specific parameters.

Table 6-3 Parameters of personnel count

Parameter	Description	Setting
Channel	Channel 1: visible. Channel 2: thermal.	[How to set] Choose one channel to set.
Enable	Enable the button to enable the alarm.	[How to set] Click Enable to enable. [Default value] OFF
OSD Enable	Enable the OSD, the count data will show on live video screen.	[How to set] Click Enable to enable. [Default value] OFF
Counting Clear Interval	The camera will clear counting data at the setting interval. Click the “Clear Counting”, clearing the data immediately.	[How to set] Choose from drop-down list. [Default value] 12 hours
Area Type	Draw a line on live video screen. The label of A and B indicate out and in.	[How to set] Choose from drop-down list. [Default value] Line
Set Correction Value	Enable, set the count correction value, it can be positive or negative. For example, if there are 30 people enter the area before counting, input 30 to correct. If 30 people go out the area, input -30.	[How to set] Enable /Input a value in the area box. [Default value] 0
Over People Number Alarm	Enable, if the counting number is passing the threshold, it will alarm.	[How to set] Click Enable to enable. [Default value] OFF
Alarm Threshold	the threshold of enable alarm.	[How to set] Enable /Input a value in the area box. [Default value] 1000

Parameter	Description	Setting
Output Channel	If you check to set the Output Channel and the device is connected to an external alarm indicator, the alarm indicator signals when an alarm is triggered.	[How to set] Click to select an ID.
Audio Detection alarm	Enable, when happen the alarm, it will be play audio to alarm. Choose the sound alarm file (set at the “ Configuration > Alarm > Sound Alarm Output ”).	[How to set] Click to enable Audio Detection Alarm [Default value] OFF
Flashlight Alarm	Enable, when it is triggered alarm, it flashes the light. But when users set the display mode to Mode 5 at “ Configuration > Thermal > Led Control Param ”interface, the lighth will be always on for 15s, not flash when it is alarm.	[How to set] Click to enable Flashlight Alarm. [Default value] OFF
Alarm Record	Enable the button to enable the alarm record.	[How to set] Click to enable Alarm Record. [Default value] OFF
SMTP	Enable the button to enable SMTP sever. The parameters of SMTP can be set at Configuration > Network Service > SMTP interface.	[How to set] Click to enable SMTP. [Default value] OFF
FTP Upload	Enable the button to enable File Transfer Protocol. The parameters of FTP can be set at Configuration > Network Service > FTP interface.	[How to set] Click to enable FTP Upload. [Default value] OFF
Video Stream Draw Line	Enable the button to enable Video Stream Draw Line, the setting area frame will show on live video.	[How to set] Click to enable Video Stream Draw Line. [Default value] OFF

Step 3 Set a deployment area.

Move the cursor to the drawing interface and click to generate a point, move the cursor to draw a line, and then click to generate another point. This is how a line is generated. In this way, continue to draw lines to form any shape, and right-click to finish line drawing.

Step 4 Set deployment time.

----**End**

6.5 Enter Area

Description

The enter area refers to that an alarm is generated when a target enter the deployment area at the valid time.

Procedure

Step 1 Select **Configuration > Intelligent Analysis > Enter Area** to access the **Enter Area** setting interface, as shown in Figure 6-6.

Figure 6-6 Enter area setting interface

Enter Area

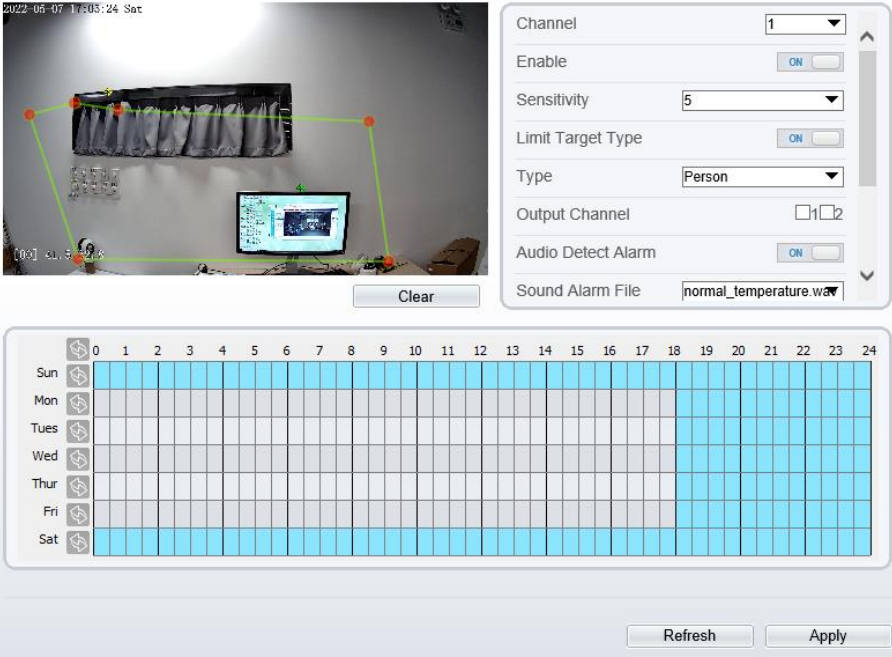

- Step 2 Set all parameters for enter area, The details please refer to *Table 6-1*.
- Step 3 Set a deployment area.

Move the cursor to the drawing interface and click to generate a point, move the cursor to draw a line, and then click to generate another point. This is how a line is generated. In this way, continue to draw lines to form any shape, and right-click to finish line drawing.

NOTE

- A drawn line cannot cross another one, or the line drawing fails.
- The quantity of deployment areas is not limited yet and will be described in future when a limit is applied.

- Step 4 Set deployment time .

---End

7 Advanced Intelligent Analysis

At advanced intelligent analysis interface, users can set the parameters of smoker detection, smoke and flame detection, fire spot detection. Enable the linkage actions, the alarm information can be sent to user by the linkage.

The advanced intelligent analysis can be used for detecting the smoking, if someone smoke in the indoor where is forbidden smoking.

Smoke and Flame Detection can be used for detecting smoke and fire, it can be sent alarm information to avoid fire getting worse.

Fire Spot Detection can be used for finding the catching fire to quickly operate to extinguish.

7.1 Smoker Detection

Description

The smoker detection function refers to that an alarm is generated when someone is smoking or generating spark at the deployment area.

Procedure

Step 1 Select **Configuration > Advanced Intelligent Analysis > Smoker Detection** to access the **Smoker Detection** interface, as shown in Figure 7-1.

Figure 7-1 Smoker detection interface

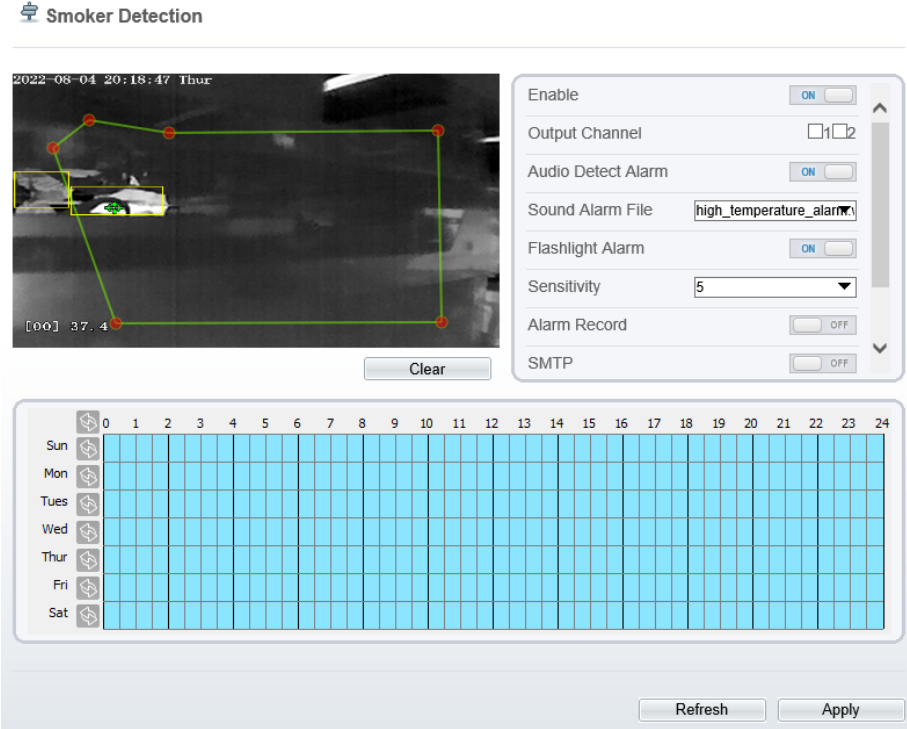

Step 2 Set all parameters for perimeter. Table 7-1 describes the specific parameters.

Table 7-1 Parameters of smoker detection

Parameter	Description	Setting
Enable	At thermal channel, Enable the button to enable the alarm.	[How to set] Click Enable to enable. [Default value] OFF
Output Channel	If you check to set the Output Channel and the device is connected to an external alarm indicator, the alarm indicator signals when an alarm is triggered.	[How to set] Click to select an ID.

Parameter	Description	Setting
Audio detection alarm	Enable, when happen the alarm, it will be play audio to alarm. Choose the sound alarm file (set at the “ Configuration > Alarm > Sound Alarm Output ”).	[How to set] Click to enable Audio Detection Alarm [Default value] OFF
Flashlight alarm	Enable, when it is triggered alarm, it flashes the light. But when users set the display mode to Mode 5 at “ Configuration > Thermal > Led Control Param ”interface, the lighth will be always on for 15s, not flash when it is alarm.	[How to set] Click to enable Flashlight Alarm. [Default value] OFF
Sensitivity	The sensitivity of detecting smoker, when the value is high, the alarm can be triggered easily, but the accuracy will be lower.	[How to set] Choose from the drop-down list [Default value] 5
Alarm Record	If you install SD card, enable this function, the device will record the alarm video.	[How to set] Click to enable Alarm Record. [Default value] OFF
SMTP	Enable the button to enable SMTP serve.	[How to set] Click to enable SMTP. [Default value] OFF
FTP Upload	Enable the button to enable File Transfer Protocol.	[How to set] Click to enable FTP Upload. [Default value] OFF
Video Stream Draw Line	Enable the button to enable Video Stream Draw Line, the setting area frame will show on live video.	[How to set] Click to enable Video Stream Draw Line. [Default value] OFF

Step 3 Set a deployment area. Move the cursor to the drawing interface and click to

generate a point, move the cursor to draw a line, and then click to generate another point. This is how a line is generated. In this way, continue to draw lines to form any shape, and right-click to finish line drawing.

 **NOTE**

- A drawn line cannot cross another one, or the line drawing fails.
- Any shape with 32 sides at most can be drawn.
- The quantity of deployment areas is not limited yet and will be described in future when a limit is applied.

Step 4 Set deployment time.

Method 1: Click left mouse button to select any time point within 0:00-24:00 from Monday to Sunday.

Method 2: Hold down the left mouse button, drag and release mouse to select the deployment time within 0:00-24:00 from Monday to Sunday.

Method 3: Click  in the deployment time page to select the whole day or whole week.

 **NOTE**

- When you select time by dragging the cursor, the cursor cannot be moved out of the time area. Otherwise, no time can be selected.

Deleting deployment time: Click  again or inverse selection to delete the selected deployment time.

Figure 7-2 Deployment time setting interface



----End

7.2 Smoke and Flame Detection

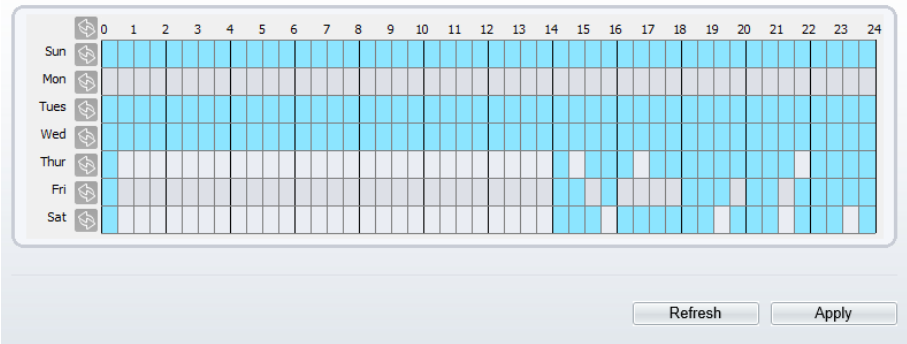
Description

The smoke flame detection function refers to that an alarm is generated when something is smoking or generating flame at the deployment area.

Procedure

Step 1 Select Configuration > Advanced Intelligent Analysis > Smoke and Flame Detection to access the Smoke and Flame Detection interface, as shown in Figure 7-3.

Figure 7-3 Smoke and flame detection interface

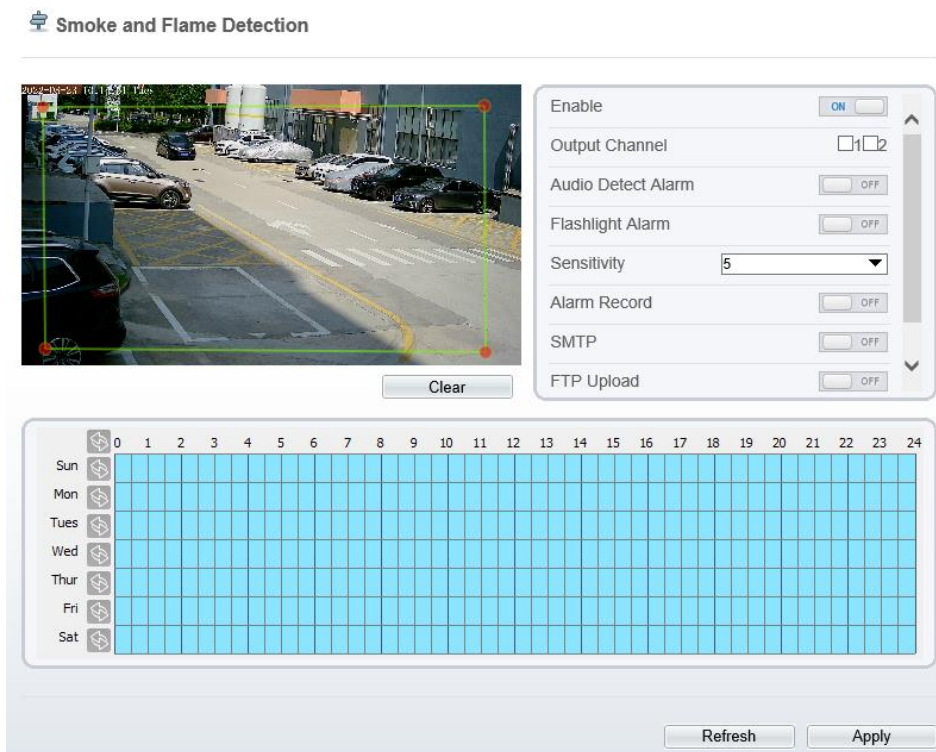

Step 5 Set all parameters for perimeter. Table 7-2 describes the specific parameters.

Table 7-2 Smoke flame detection description

Parameter	Description	Setting
Enable	At thermal channel, Enable the button to enable the alarm.	[How to set] Click Enable to enable. [Default value] OFF
Output Channel	If you check to set the Output Channel and the device is connected to an external alarm indicator, the alarm indicator signals when an alarm is triggered.	[How to set] Click to select an ID.
Audio detection alarm	Enable, when happen the alarm, it will be play audio to alarm. Choose the sound alarm file (set at the “ Configuration > Alarm > Sound Alarm Output ”).	[How to set] Click to enable Audio Detection Alarm [Default value] OFF
Flashlight alarm	Enable, when it is triggered alarm, it flashes the light. But when users set the display mode to Mode 5 at “ Configuration > Thermal > Led Control Param ”interface, the lighth will be always on for 15s, not flash when it is alarm.	[How to set] Click to enable Flashlight Alarm. [Default value] OFF
Alarm Record	If you install SD card, enable this function, the device will record the alarm video.	[How to set] Click to enable Alarm Record. [Default value] OFF
SMTP	Enable the button to enable SMTP serve.	[How to set] Click to enable SMTP. [Default value] OFF
FTP Upload	Enable the button to enable File Transfer Protocol.	[How to set] Click to enable FTP Upload. [Default value] OFF

Parameter	Description	Setting
Video Stream Draw Line	Enable the button, the draw line will show at live video when the stream is stream 2.	[How to set] Click to enable Video Stream Draw Line. [Default value] OFF

Step 2 Set a deployment area. Move the cursor to the drawing interface and click to generate a point, move the cursor to draw a line, and then click to generate another point. This is how a line is generated. In this way, continue to draw lines to form any shape, and right-click to finish line drawing.

**NOTE**

- A drawn line cannot cross another one, or the line drawing fails.
- Any shape with 32 sides at most can be drawn.
- The quantity of deployment areas is not limited yet and will be described in future when a limit is applied.

Step 3 Set deployment time.

Method 1: Click left mouse button to select any time point within 0:00-24:00 from Monday to Sunday.

Method 2: Hold down the left mouse button, drag and release mouse to select the deployment time within 0:00-24:00 from Monday to Sunday.

Method 3: Click  in the deployment time page to select the whole day or whole week.

**NOTE**

- When you select time by dragging the cursor, the cursor cannot be moved out of the time area. Otherwise, no time can be selected.

Deleting deployment time: Click  again or inverse selection to delete the selected deployment time.

Figure 7-4 Deployment time setting interface



----End

7.3 Fire Spot Detection

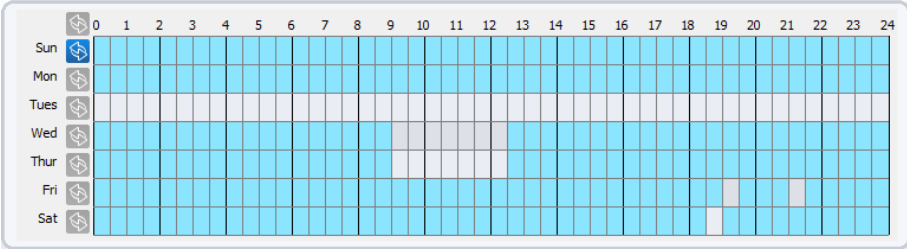
Description

The fire spot detection function refers to that an alarm is generated when something is fire at the deployment area.

Procedure

Step 1 Select **Configuration > Advanced Intelligent Analysis > Fire Spot Detection** to access the **Fire Spot Detection** interface, as shown in Figure 7-5

Figure 7-5 Fire spot detection interface

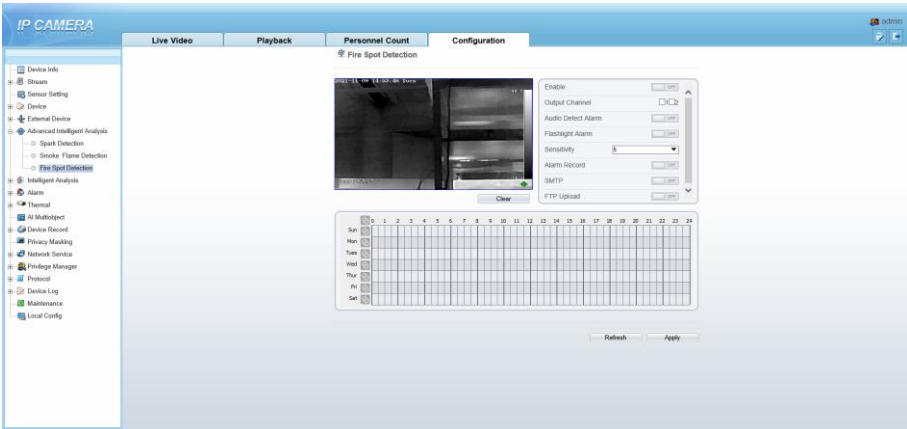

Step 2 Set all parameters for perimeter. Table 7-3 describes the specific parameters.

Table 7-3 Fire spot detection description

Parameter	Description	Setting
Enable	At thermal channel, Enable the button to enable the alarm.	[How to set] Click Enable to enable. [Default value] OFF
Output Channel	If you check to set the Output Channel and the device is connected to an external alarm indicator, the alarm indicator signals when an alarm is triggered.	[How to set] Click to select an ID.
Audio Detection Alarm	Enable, when happen the alarm, it will be play audio to alarm. Choose the sound alarm file (set at the “ Configuration > Alarm > Sound Alarm Output ”).	[How to set] Click to enable Audio Detection Alarm [Default value] OFF
Flashlight alarm	Enable, when it is triggered alarm, it flashes the light. But when users set the display mode to Mode 5 at “ Configuration > Thermal > Led Control Param ”interface, the lighth will be always on for 15s, not flash when it is alarm.	[How to set] Click to enable Flashlight Alarm. [Default value] OFF
Alarm Record	If you install SD card, enable this function, the device will record the alarm video.	[How to set] Click to enable Alarm Record. [Default value] OFF
SMTP	Enable the button to enable SMTP serve.	[How to set] Click to enable SMTP. [Default value] OFF
FTP Upload	Enable the button to enable File Transfer Protocol.	[How to set] Click to enable FTP Upload. [Default value] OFF

Parameter	Description	Setting
Video Stream Draw Line	Enable the button to enable Video Stream Draw Line, the setting area frame will show on live video.	[How to set] Click to enable Video Stream Draw Line. [Default value] OFF

Step 3 Set a deployment area.

Use mouse to draw rectangular area, you can set several area to deploy, as shown in Figure 7-6.

Figure 7-6 Set deployment area



 **NOTE**

- A drawn line cannot cross another one, or the line drawing fails.
- Any shape with 32 sides at most can be drawn.
- The quantity of deployment areas is not limited yet and will be described in future when a limit is applied.

Step 4 Set deployment time.

Method 1: Click left mouse button to select any time point within 0:00-24:00 from Monday to Sunday.

Method 2: Hold down the left mouse button, drag and release mouse to select the deployment time within 0:00-24:00 from Monday to Sunday.

Method 3: Click  in the deployment time page to select the whole day or whole week.

 **NOTE**

- When you select time by dragging the cursor, the cursor cannot be moved out of the time area. Otherwise, no time can be selected.

Deleting deployment time: Click  again or inverse selection to delete the selected deployment time.

Figure 7-7 Deployment time setting interface



---End

8 AI Multi-object

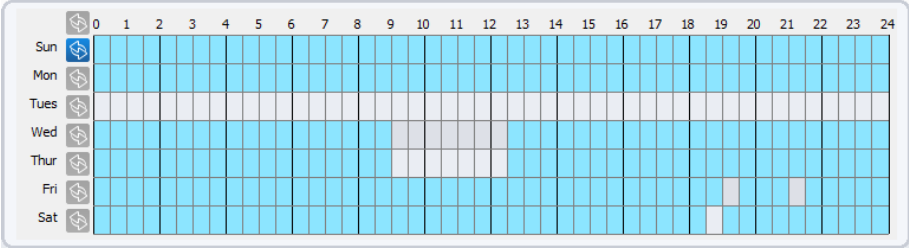
Step 1 At **Configuration > AI Multiobject** interface, user can enable full-body detection, vehicle detection to detect the person and vehicle, as shown in Figure 8-1.

Figure 8-1 AI multiobject

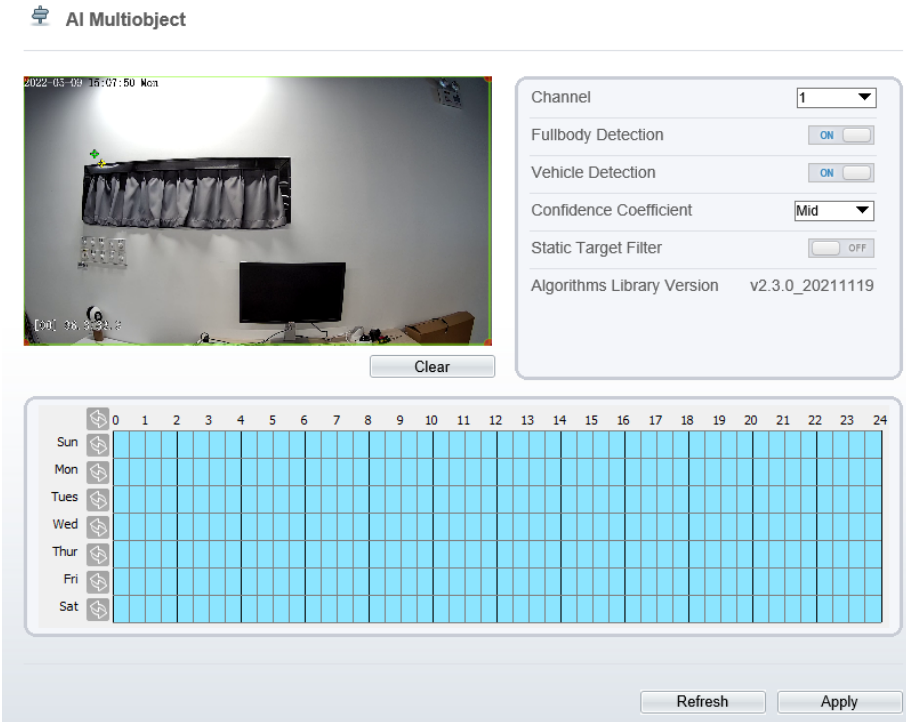

Step 2 Set the parameters of AI multiobject following as the Table 8-1 .

Table 8-1 AI multiobject parameters

Parameter	Description	How to set
Channel	Channel 1 is visible channel. Channel 2 is thermal channel.	Choose from drop list.
Full body detection	The camera will snap the whole body when someone appear in live video. The detection frame	Enable

	is blue.	
Vehicle detection	The camera will snap the licence when the vehicle appear in live video. The detection frame is yellow.	Enable
Confidence Coefficient	The range of snap image, there are three type, such as high, mid and low. The higher the confidence, the better the snap quality and the fewer snapshots.	Choose from drop list.
Static Target Filter	If the target is static, the device will filter this target. For example, if a car stop for long time, the device will be filtered.	Enable

Step 3 Draw the detection area by using the mouse.

Step 4 Set the schedule, click “Apply” to save the settings.

---End

9 Alarm Setting

9.1 Alarm Output

Procedure

- Step 1 Select **Configuration > Alarm > Alarm Output** to access the **Alarm Output** setting interface, as shown in Figure 9-1.

Figure 9-1 Alarm output interface

Alarm Output	
Alarm Output	1
Name	
Valid Signal	Close
Alarm Output Mode	Switch Mode
Alarm Time(ms)(0:Continuous)	0

Timing Alarm Output OFF

Manual control

- Step 2 Set alarm output of channel, name, enable valid signal and alarm time choose alarm output mode.
- Step 3 You can also control alarm manually, click **Start** button to start alarm, click stop button to end the alarm .

---End

9.2 Disk Alarm

Procedure

Step 1 Select **Configuration > Alarm > Disk Alarm** to access the disk alarm setting interface, as shown in Figure 9-2.

Figure 9-2 Disk alarm interface

Disk Alarm

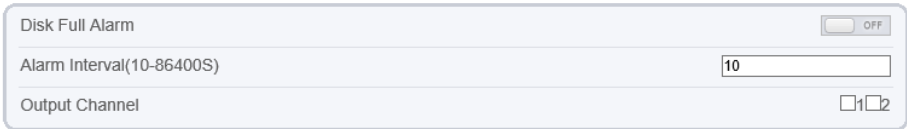

Disk Full Alarm	<input type="checkbox"/> OFF
Alarm Interval(10-86400S)	10
Output Channel	<input type="checkbox"/> 1 <input type="checkbox"/> 2

Refresh

Apply

Step 2 Enable the disk full alarm, when the disk is full it will alarm.

Step 3 Set alarm interval and tick output channel.

Step 4 Click **Apply** to save the settings, click refresh will return last settings.

---End

9.3 Network Alarm

Procedure

Step 1 Select **Configuration > Alarm > Network Alarm** to access the network alarm setting interface, as shown in Figure 9-3.

Figure 9-3 Network alarm interface

Network Alarm

Network Card ID: 1

Exceptional Alarm: ON

Alarm Interval(10-86400S): 10

Output Channel: 1 2

Alarm Record: OFF

Refresh Apply

Step 2 Choose network card ID and enable exceptional alarm to set alarm interval. Tick output channel.

Step 3 Click **Apply** to save the settings, click refresh will return last settings.

---End

9.4 I/O Alarm Linkage

Procedure

Step 1 Select **Configuration > Alarm > I/O Alarm Linkage** to access the **I/O alarm Linkage** setting interface, as shown in Figure 9-4.

Figure 9-4 I/O alarm linkage interface

I/O Alarm Linkage

Alarm Input

Name

Trigger Mode

Alarm Input ON

Output Channel 1 2

PTZ Linkage OFF

Alarm Record OFF

SMTP OFF

	0	1	2	3	4	5	6	7	8	9	10	11	12	13	14	15	16	17	18	19	20	21	22	23	24
Sun	<input type="checkbox"/>	<input type="checkbox"/>	<input type="checkbox"/>	<input type="checkbox"/>	<input type="checkbox"/>	<input type="checkbox"/>	<input type="checkbox"/>	<input type="checkbox"/>	<input type="checkbox"/>	<input type="checkbox"/>	<input type="checkbox"/>	<input type="checkbox"/>	<input type="checkbox"/>	<input type="checkbox"/>	<input type="checkbox"/>	<input type="checkbox"/>	<input type="checkbox"/>	<input type="checkbox"/>	<input type="checkbox"/>	<input type="checkbox"/>	<input type="checkbox"/>	<input type="checkbox"/>	<input type="checkbox"/>	<input type="checkbox"/>	<input type="checkbox"/>
Mon	<input type="checkbox"/>	<input type="checkbox"/>	<input type="checkbox"/>	<input type="checkbox"/>	<input type="checkbox"/>	<input type="checkbox"/>	<input type="checkbox"/>	<input type="checkbox"/>	<input type="checkbox"/>	<input type="checkbox"/>	<input type="checkbox"/>	<input type="checkbox"/>	<input type="checkbox"/>	<input type="checkbox"/>	<input type="checkbox"/>	<input type="checkbox"/>	<input type="checkbox"/>	<input type="checkbox"/>	<input type="checkbox"/>	<input type="checkbox"/>	<input type="checkbox"/>	<input type="checkbox"/>	<input type="checkbox"/>	<input type="checkbox"/>	<input type="checkbox"/>
Tues	<input type="checkbox"/>	<input type="checkbox"/>	<input type="checkbox"/>	<input type="checkbox"/>	<input type="checkbox"/>	<input type="checkbox"/>	<input type="checkbox"/>	<input type="checkbox"/>	<input type="checkbox"/>	<input type="checkbox"/>	<input type="checkbox"/>	<input type="checkbox"/>	<input type="checkbox"/>	<input type="checkbox"/>	<input type="checkbox"/>	<input type="checkbox"/>	<input type="checkbox"/>	<input type="checkbox"/>	<input type="checkbox"/>	<input type="checkbox"/>	<input type="checkbox"/>	<input type="checkbox"/>	<input type="checkbox"/>	<input type="checkbox"/>	<input type="checkbox"/>
Wed	<input type="checkbox"/>	<input type="checkbox"/>	<input type="checkbox"/>	<input type="checkbox"/>	<input type="checkbox"/>	<input type="checkbox"/>	<input type="checkbox"/>	<input type="checkbox"/>	<input type="checkbox"/>	<input type="checkbox"/>	<input type="checkbox"/>	<input type="checkbox"/>	<input type="checkbox"/>	<input type="checkbox"/>	<input type="checkbox"/>	<input type="checkbox"/>	<input type="checkbox"/>	<input type="checkbox"/>	<input type="checkbox"/>	<input type="checkbox"/>	<input type="checkbox"/>	<input type="checkbox"/>	<input type="checkbox"/>	<input type="checkbox"/>	<input type="checkbox"/>
Thur	<input type="checkbox"/>	<input type="checkbox"/>	<input type="checkbox"/>	<input type="checkbox"/>	<input type="checkbox"/>	<input type="checkbox"/>	<input type="checkbox"/>	<input type="checkbox"/>	<input type="checkbox"/>	<input type="checkbox"/>	<input type="checkbox"/>	<input type="checkbox"/>	<input type="checkbox"/>	<input type="checkbox"/>	<input type="checkbox"/>	<input type="checkbox"/>	<input type="checkbox"/>	<input type="checkbox"/>	<input type="checkbox"/>	<input type="checkbox"/>	<input type="checkbox"/>	<input type="checkbox"/>	<input type="checkbox"/>	<input type="checkbox"/>	<input type="checkbox"/>
Fri	<input type="checkbox"/>	<input type="checkbox"/>	<input type="checkbox"/>	<input type="checkbox"/>	<input type="checkbox"/>	<input type="checkbox"/>	<input type="checkbox"/>	<input type="checkbox"/>	<input type="checkbox"/>	<input type="checkbox"/>	<input type="checkbox"/>	<input type="checkbox"/>	<input type="checkbox"/>	<input type="checkbox"/>	<input type="checkbox"/>	<input type="checkbox"/>	<input type="checkbox"/>	<input type="checkbox"/>	<input type="checkbox"/>	<input type="checkbox"/>	<input type="checkbox"/>	<input type="checkbox"/>	<input type="checkbox"/>	<input type="checkbox"/>	<input type="checkbox"/>
Sat	<input type="checkbox"/>	<input type="checkbox"/>	<input type="checkbox"/>	<input type="checkbox"/>	<input type="checkbox"/>	<input type="checkbox"/>	<input type="checkbox"/>	<input type="checkbox"/>	<input type="checkbox"/>	<input type="checkbox"/>	<input type="checkbox"/>	<input type="checkbox"/>	<input type="checkbox"/>	<input type="checkbox"/>	<input type="checkbox"/>	<input type="checkbox"/>	<input type="checkbox"/>	<input type="checkbox"/>	<input type="checkbox"/>	<input type="checkbox"/>	<input type="checkbox"/>	<input type="checkbox"/>	<input type="checkbox"/>	<input type="checkbox"/>	<input type="checkbox"/>

- Step 2 Choose alarm input and trigger mode, set name, enable other linkages such as alarm input, PTZ linkage, Alarm Record SMTP, FTP upload, IR Cut and flashlight alarm.
- Step 3 Set alarm schedule, choose the duration of linkage.
- Step 4 Click **Apply** to save the settings, click refresh will return last settings.

---End

9.5 Motion Alarm

Procedure

- Step 1 Select **Configuration > Alarm > Motion Alarm** to access the **Motion Alarm** setting interface, as shown in Figure 9-5.

Figure 9-5 Motion alarm interface

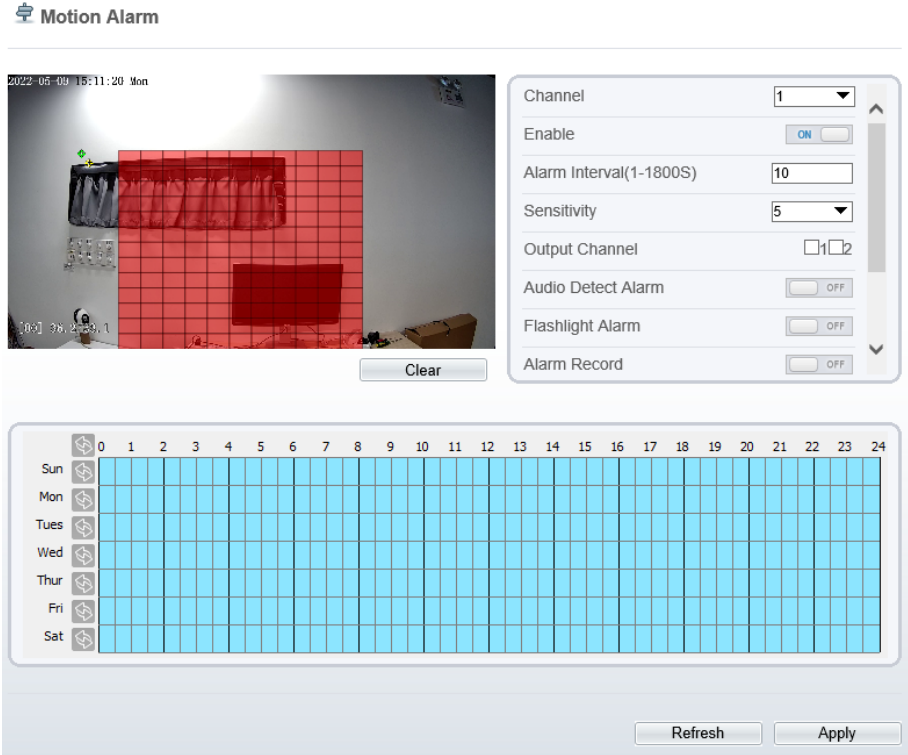

- Step 2 Choose channel and enable the motion alarm, set alarm interval and sensitivity, enable other linkages such as SMTP, FTP upload and motion detect stream.
- Step 3 Set motion alarm schedule,
- Step 4 Click **Apply** to save the settings, click **Refresh** will return last settings.

---End

9.6 Push Message

Procedure

- Step 1 Select **Configuration > Alarm > Push Message** to access the **Push Message** setting interface, as shown in Figure 9-6.

Figure 9-6 Push message interface

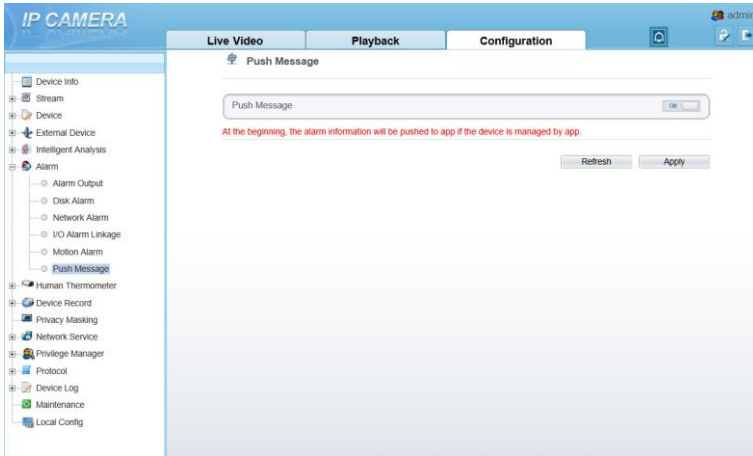

- Step 2 Enable the push message, you will receive the message when the alarm happened.
- Step 3 Click **Apply** to save the settings, click **Refresh** will return last settings.

---End

9.7 Audio Abnormal Output

Procedure

- Step 1 Select **Configuration > alarm > Audio Abnormal Output** to access the **Sound Alarm Output** setting interface, as shown in Figure 9-7.

Figure 9-7 Audio abnormal output interface

 **Audio Abnormal Detection**

Enable	<input type="checkbox"/> OFF
Sudden Rise	<input type="checkbox"/> OFF
Sudden Drop	<input type="checkbox"/> OFF
Output Channel	<input type="checkbox"/> 1 <input type="checkbox"/> 2
Alarm Record	<input type="checkbox"/> OFF
SMTP	<input type="checkbox"/> OFF
FTP Upload	<input type="checkbox"/> OFF

Real Time Volume

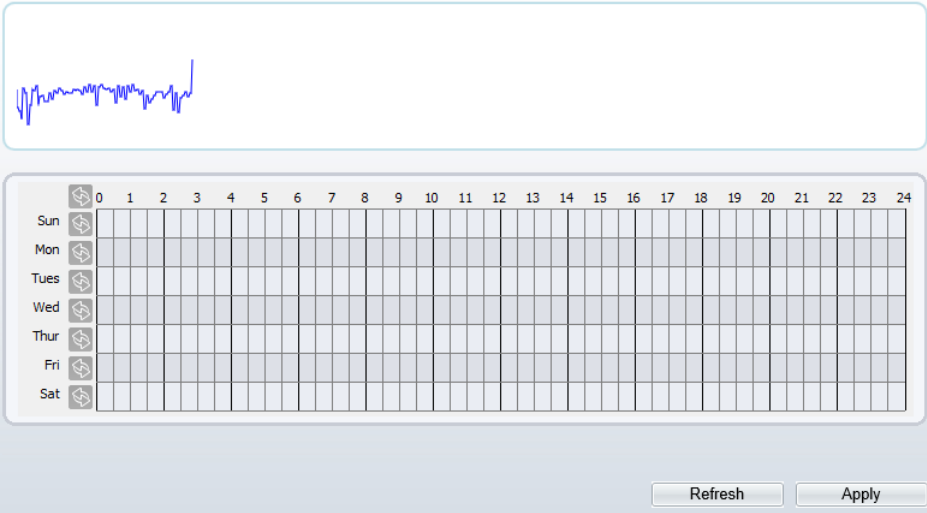

- Step 2 Enable the audio abnormal detection, enable sudden rise, sudden drop, when happen the condition of enable, it will alarm.
- Step 3 Tick the output channel, enable alarm record, SMTP, FTP upload and motion detect stream.
- Step 4 Set alarm schedule, choose the duration of linkage.
- Step 5 Click **Apply** to save the settings, click **Refresh** will return last settings.

---End

10 Other Web Configurations

10.1 Device Information

You can view the information about device, as shown in Figure 10-1.

Figure 10-1 Device information interface

 **Device Info**

Device ID	125DF5
Device Name	<input type="text"/> 
MAC Address	00:1C:27:12:5D:F5

Camera Type	Thermal Device
Product Model	SN-TPC2552DT-23
Manufacturer Name	IPCamera

Hardware Version	V170062_1
Firmware Version	v3.6.0840.1004.3.0.5.3.0
Uboot Version	v6.2_20201113
Kernel Version	v6.1_20201113

Channel Quantity	2
Alarm Input Quantity	2
Alarm Output Quantity	2
Serial Port Quantity	1
Network Card Quantity	1

10.2 Stream

10.2.1 Base Stream

Step 1 Choose **Configuration > Stream > Base Stream**, as shown in Figure 10-2.

Figure 10-2 Base stream interface

 Stream

Channel	1
Stream ID	1
Name	stream1
Video Encode Type	H265
Video Encode Level	Mid
Audio Encode Type	G711_ALAW
Resolution	1920x1080
Frame Rate(fps)	30
I Frame Interval(Unit: Frame)	60
Bit Rate Type	CBR
Bit Rate(kbps)(500-12000)	4096
Smart Encode	<input type="checkbox"/> OFF

Figure 10-3 Channel 2 (thermal channel) stream

 Stream

Channel	2
Stream ID	1
Name	stream1
Video Encode Type	H265
Video Encode Level	Mid
Audio Encode Type	G711_ALAW
Resolution	D1
Frame Rate(fps)	25
I Frame Interval(Unit: Frame)	50
Bit Rate Type	CBR
Bit Rate(kbps)(100-6000)	2000
Smart Encode	<input type="checkbox"/> OFF

- Step 2 Choose channel, stream ID, video encode type, video encode level, audio encode type, resolution, frame rate, frame interval, bit rate type and bit rate from all drop list.
- Step 3 Set name of base stream, enable smart encode.
- Step 4 Click **Apply**. The message "**Apply success**" is displayed, the system saves the settings.

---End

10.2.2 ROI

- Step 1 Choose **Configuration > Stream >ROI**, as shown in Figure 10-4.

Figure 10-4 ROI interface

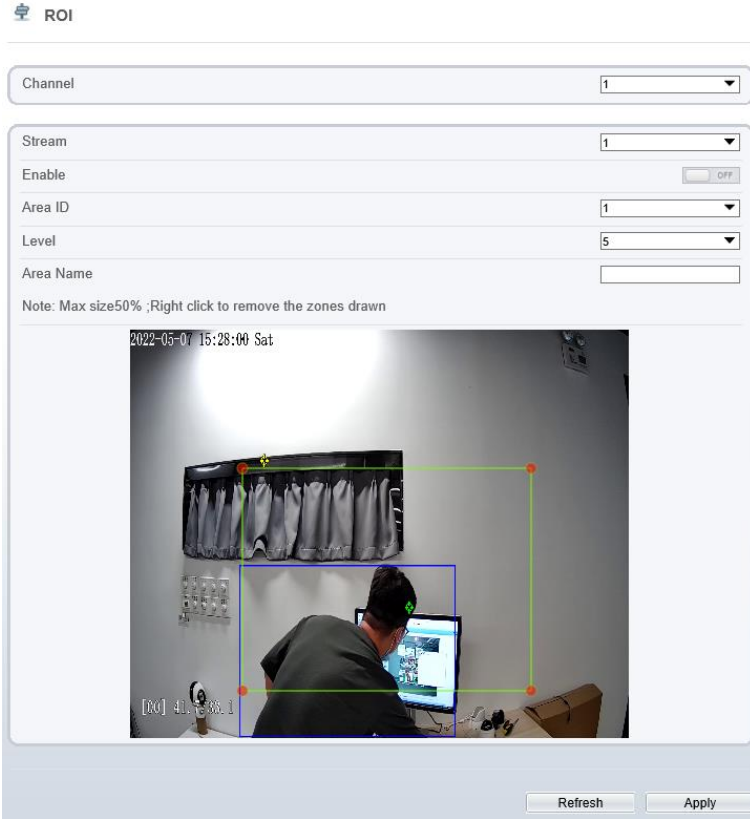

Step 2 Click **Apply**. The message "**Apply success**" is displayed, the system saves the settings.

---End

10.2.3 Snapshot

Step 1 Choose **Configuration > Stream > Snapshot**, as shown in Figure 10-5.

Figure 10-5 Snapshot interface

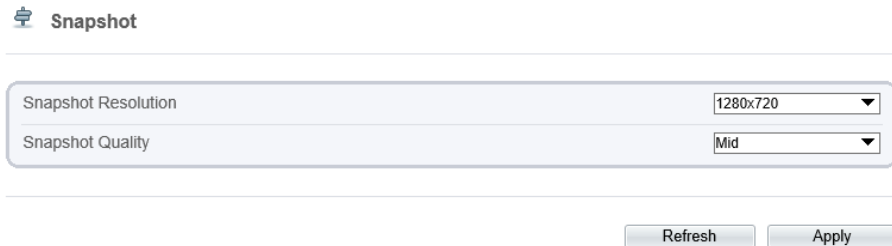

The screenshot shows the 'Snapshot' configuration page. It features two dropdown menus: 'Snapshot Resolution' set to '1280x720' and 'Snapshot Quality' set to 'Mid'. Below these are two buttons: 'Refresh' and 'Apply'.

- Step 2 Choose snapshot resolution and snapshot quality from drop list.
Step 3 Click **Apply**. The message "Apply success" is displayed, the system saves the settings.

---End

10.3 Device

You can set local network, device port, data and time, camera, OSD, microphone, CVBS, system, voice denoise and software licenses, as shown in Figure 10-6.

Figure 10-6 Device interface

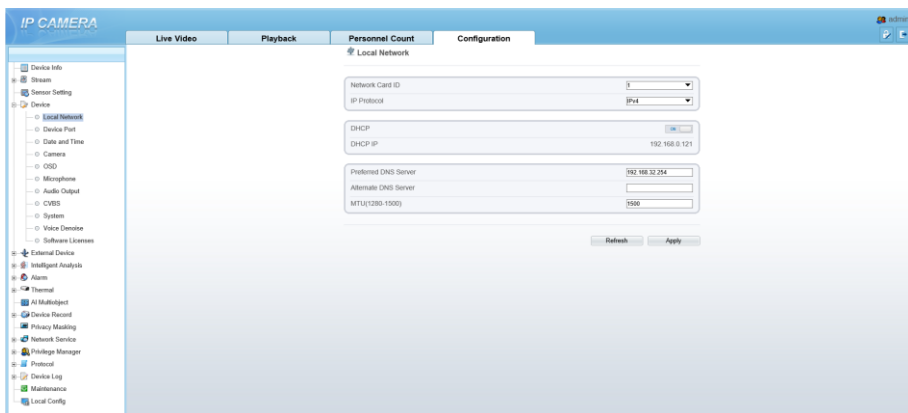

The screenshot shows the 'Device' configuration page under the 'Configuration' tab. The 'Local Network' section is active, showing fields for 'Network Card ID', 'IP Protocol' (set to 'IPv4'), 'DHCP' (checked), 'DHCP IP' (192.168.0.121), 'Preferred DNS Server' (192.168.32.254), 'Alternate DNS Server', and 'MTU (1280-1500)' (1500). 'Refresh' and 'Apply' buttons are at the bottom.

10.4 External Device

The camera is connected PTZ external device, you can choose **Configuration > External Device**, enable PTZ, set parameters as shown in Figure 10-7.

Figure 10-7 External device interface

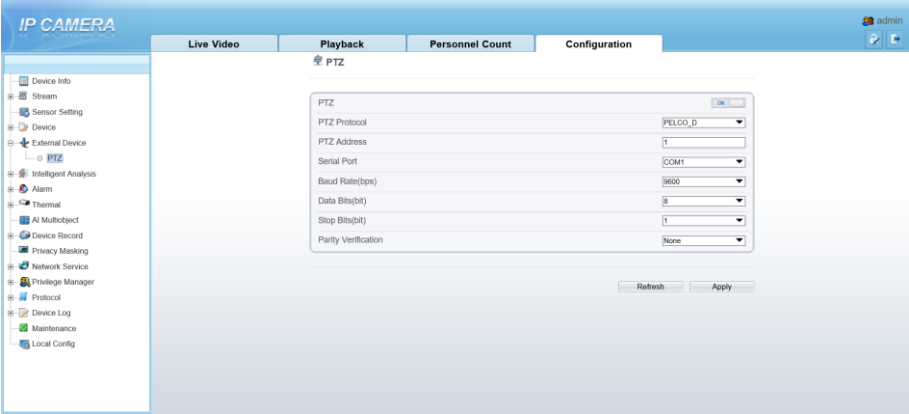

10.5 Privacy Masking

Choose **Configuration > Privacy masking**. You can set privacy masking if some area needs keep secret, drag mouse to select the area to cover, double click will delete the setting, as shown in Figure 10-8.

Figure 10-8 Privacy masking interface

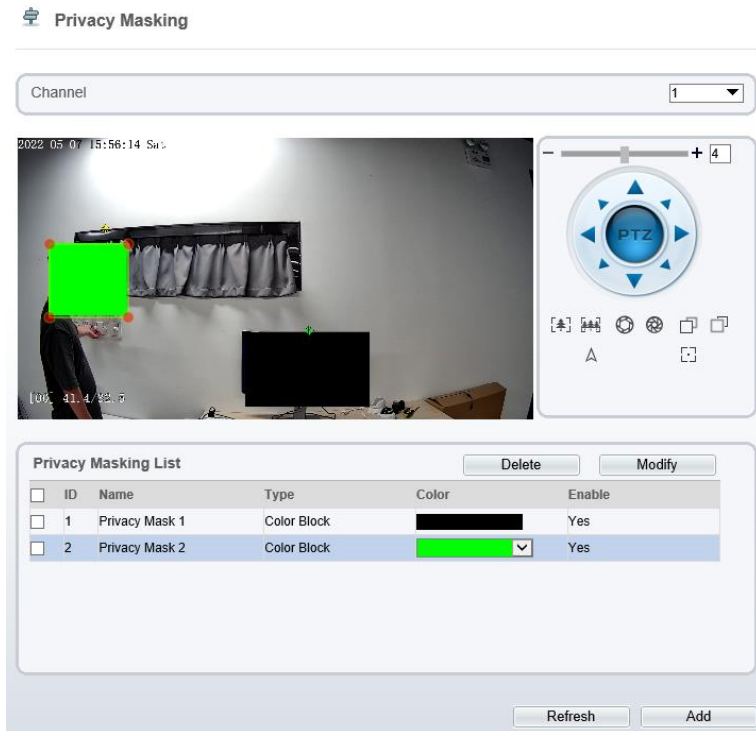

10.6 Network Service

Choose **Configuration > Network Service**. You can set **802.1x, DDNS, PPPoE, Port mapping, SMTP, IP filter, CGI alarm service center, SNMP and QOS**

10.7 Privacy Manager

Add user account, manage the users' permission. As shown in Figure 10-9.

Figure 10-9 Privacy manager interface

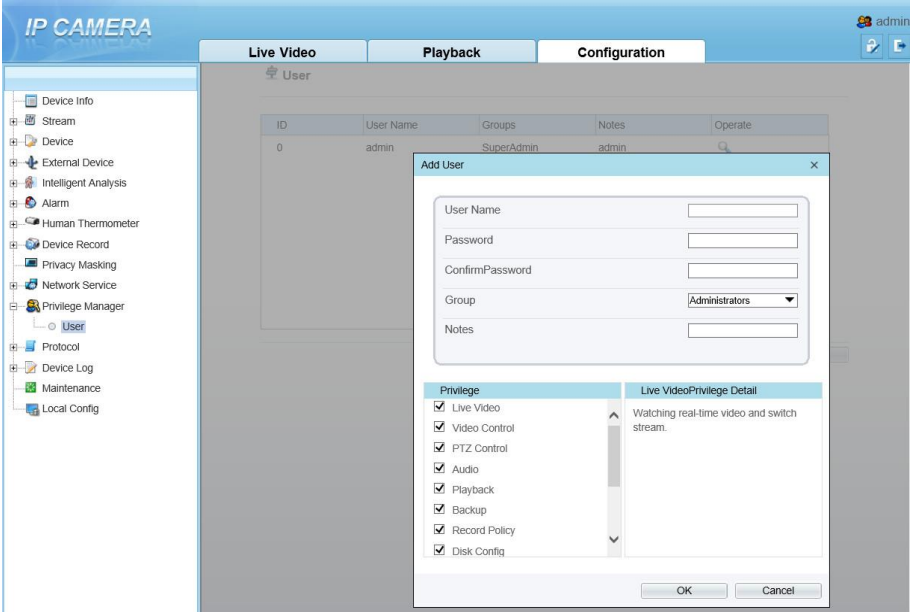

10.8 Protocol

Choose **Configuration > Protocol**. You can set **protocol information, security, CMS configuration and multicast parameter**.

Figure 10-10 Protocol interface

Protocol Info

Protocol Name: ONVIF

Protocol Version: v17.06

Protocol Software Version: v17.06_build000360

RTSP Rule: rtsp://ip.port/sn1/live/cameraid/streamid

RTSP Example: rtsp://192.168.0.121:554/sn1/live/1/1

Onvif UUID: f5bc7680-bff8-11d3-844f-

Refresh

10.9 Device Log

Choose **Configuration > Device Log**. You can view **operation log** and **alarm log**, or collect all log information, as shown in Figure 10-11.

Figure 10-11 Device log interface

IP CAMERA

admin

Live Video | Playback | Personnel Count | Configuration

Operation Log

Operation Log: All Type

Begin Time: 2022-05-06 15:59:15

End Time: 2022-05-07 15:59:15

Download Query

Time	User Name	Log Info
2022-05-07 15:58:50	admin	Stop video
2022-05-07 15:58:50	admin	Stop IntelligenceAnalyse Stream
2022-05-07 15:58:09	admin	Configure blind area
2022-05-07 15:58:06	admin	Configure blind area
2022-05-07 15:58:03	admin	Configure blind area
2022-05-07 15:58:00	admin	Configure blind area
2022-05-07 15:55:58	admin	Configure blind area
2022-05-07 15:55:56	admin	Configure blind area
2022-05-07 15:55:54	admin	Configure blind area
2022-05-07 15:55:53	admin	Start IntelligenceAnalyse Stream

Navigation: < 1 >

10.10 Maintenance

Choose **configuration > maintenance**. You can **restart, update, reserve IP setting and restore to factory default**, as shown in Figure 10-12.

Figure 10-12 Maintenance interface

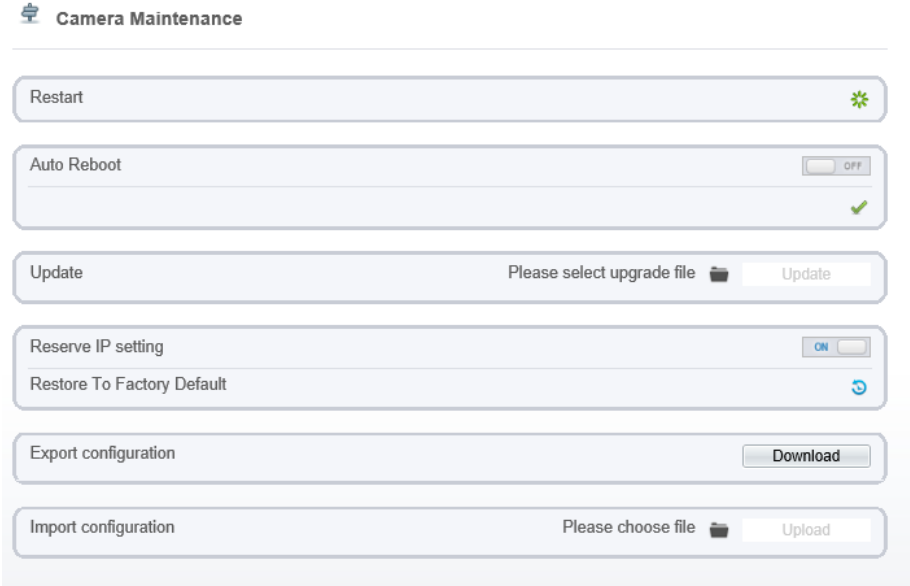

10.11 Local Config

Choose **configuration > local config**. You can choose the snapshot picture format, change the save path of snapshot and local record, as shown in Figure 10-13.

Figure 10-13 Local config interface



The screenshot shows the 'Local Config' interface with the following settings:

Field	Value
Snapshot picture format	jpg
SnapShot Save Path	D:\LocalStorage\
Local Record Save Path	D:\LocalStorage\
Local Record File Size(8-128M)	64
Hardware Decode	OFF

At the bottom of the interface, there are two buttons: 'Refresh' and 'Apply'.

10.12 QOS

Description

If the device is connected to a router or switch with a QOS function, and the priority rule of the corresponding mark is configured on the network device, the network device will preferentially pass the data packet of the corresponding mark.

Procedure

Step 1 Choose **Configuration > Network Service > QOS**.

The **QOS** page is displayed, as shown in Figure 10-14.

Figure 10-14 QOS page



Audio/Video Dscp(0-63)	<input type="text" value="52"/>
Alarm Dscp(0-63)	<input type="text" value="0"/>
Command Dscp(0-63)	<input type="text" value="0"/>

Refresh

Apply

Step 2 Input the value range from 0 to 63 (audio/video dscp, alarm dscp and command dscp).

Step 3 Click **Apply**.

The message "Apply success!" is displayed, and the system saves the settings.

---End

A Troubleshooting

Common Trouble	Possible Cause	Solution
Unable to access the web	Network is not connected.	Connect the network cable of the camera to the PC to check whether the network cable is in good contact. Run the ping command to check the network connection and whether the device works normally.
	IP address is occupied.	Directly connect the camera to the PC, and reset the IP address of the camera.
	The IP addresses of the PC and the device are in different networks.	Check the IP address, subnet mask and gateway setting of the camera.
The measured temperature is not accurate.	The device is just powered on, and the temperature of the cavity is unstable.	The temperature of the cavity is stable within 15 to 30 minutes after the device is powered on.
	The target configuration is incorrect.	Check whether the emission rate and distance of the target are configured correctly.
An error occurs in accessing the web of the device after the upgrade.	The data in the cache of browser is not updated in time.	Delete the cache of browser. The steps are as follows (taking IE9 as an example): Open the Internet Explorer. Press Ctrl + Shift + Delete on keyboard. The Delete Browsing History dialog box appears. Select all check boxes. Click Clear now . Relogin the web page of the camera.
Upgrade failed.	No network cable is connected. The network setting is incorrect.	Ensure the upgrade network is connected. Check whether the network setting is correct.
	The upgrade package is incorrect.	Perform the correct upgrade package again.

Common Trouble	Possible Cause	Solution
The temperature is too high.	1. Make sure ‘ thermal mapping ’ and ‘ thermal calibration is configured correctly ’ by checking highest temperature object at two channels. 2. Check if the temperature data is inconsistent with the actual temperature, the temperature may be too high.	

101-300-0594-02