

Network Video Recorder(NVR) Quick Setup Guide

NO.:101-600-0366-01
Issue:1.0

Precautions

Fully understand this document before using this device, and strictly observe rules in this document when using this device. If you install this device in public places, provide the tip "You have entered the area of electronic surveillance" in an eye-catching place. Failure to correctly use electrical products may cause fire and severe injuries.

WARNING	It alerts you to moderate dangers which, if not avoided, may cause minor or moderate injuries.
CAUTION	It alerts you about risks. Neglect of these risks may cause device damage, data loss, device performance deterioration, or unpredictable results.
NOTE	It provides additional information.

- WARNING**
 - Strictly observe installation requirements when installing the device. The manufacturer shall not be liable for device damage caused by users' non-conformance to these requirements.
- Strictly conform to local electrical safety standards and use power adapters that are marked with the LPS standard when installing and using this device. Otherwise, this device may be damaged.
- Use accessories delivered with this device. The voltage must meet input voltage requirements for this device.
- If this device is installed in places with unsteady voltage, ground this device to discharge high energy such as electrical surges in order to prevent the power supply from burning out.
- When this device is in use, ensure that no water or any liquid flows into the device. If water or liquid unexpectedly flows into the device, immediately power off the device and disconnect all cables (such as power cables and network cables) from this

device.

- If this device is installed in places where thunder and lightning frequently occur, ground the device nearby to discharge high energy such as thunder strikes in order to prevent device damage.

CAUTION

- Avoid heavy loads, intensive shakes, and soaking to prevent damages during transportation and storage. The warranty does not cover any device damage that is caused during secondary packaging and transportation after the original packaging is taken apart.
- Protect this device from fall-down and intensive strikes, keep the device away from magnetic field interference, and do not install the device in places with shaking surfaces or under shocks.
- Clean the device with a soft dry cloth. For stubborn dirt, dip the cloth into slight neutral cleanser, gently wipe the dirt with the cloth, and then dry the device.
- Do not jam the ventilation opening. Follow the installation instructions provided in this document when installing the device.
- Keep the device away from heat sources such as radiators, electric heaters, or other heat equipment.
- Keep the device away from moist, dusty, extremely hot or cold places.
- If the device is installed outdoors, take insect- and moisture-proof measures to avoid circuit board corrosion that can affect monitoring.
- Remove the power plug if the device is idle for a long time.
- When unpacking, please first confirm whether fragile label is damaged, if damaged, please contact customer service or sales personnel in time. The company will not be liable for any human-made damage to fragile labels.

Special Announcement

- All complete products sold by the manufacturer are delivered along with nameplates, quick setup guide and accessories after strict inspection. The manufacturer shall not be liable for counterfeit products.
- The manufacturer will update this manual according to product function enhancement or changes and regularly update the software and hardware described in this manual. The updated content will be added to new versions of this manual without prior notice.
- This manual may contain misprints, technology information that is not accurate enough, or product function and operation description that is slightly inconsistent with the actual product, the final interpretation of company is as a standard.
- This manual is only for reference and does not ensure that the information is totally consistent with the actual product. For consistency, see the actual product.

NOTE

For more information, please refer to our website.

1 Open Package Examination

Open the package, check the appearance of product for no obvious damage, and confirm the item list for table 1-1 is consistent.

Table 1-1 Packing list

Component	Quantity	Remark
Network video recording	1	
Quick Setup Guide	1	
Mouse	1	
Green female wiring terminal	2(8)	
Power Cord	1	
Hanger	2	
Countersunk head black screws	6	
Countersunk head imperial white screws	24	

2 Device Structure

2.1 Device Ports

NOTE

Different devices may have different ports and multi-head cables; Please refer to the actual product.

For front panel description of device refer to table 2-1.

Table 2-1 Front panel description

Port Name	Description
PWR Indicator	When the NVR is operating, the PWR indicator is steady on. When the NVR is shut down, the PWR indicator is off.
HDD Indicator	Hard disk status indicator. This indicator flashes when data is transmitted.
PoE Indicator	PoE network status indicator. This indicator flashes when data is transmitted.
USB 2.0	Support connected to an USB mouse or USB disk.

For rear panel description of device, please refer to table 2-2.

Table 2-2 Rear panel description

Port Name	Description
PoE Port	PoE port interfaces, connect cameras by ports.
WAN	RJ 1000 Mbps adaptive Ethernet interface, connect to Internet.
LAN	RJ 1000 Mbps adaptive Ethernet interface, connect to intranet, or access to webs of PoE cameras.
Audio out/ Audio in	Audio output and audio input.
VGA	Video output interface. If the Auxiliary Screen is enable, HDMI's output is main screen, VGA's output is auxiliary screen.
HDMI	External hard disk interface.
USB 3.0	Support connected to 3.0 U disk.
RS232	Standard Rs232 serial communication interface of the device.
ALARM I/O RS 485	Alarm input and alarm output. A is RS 485+, B is RS485-
	Safe ground screw of the device.
	Power switch.
	AC 110V/220V power input interface.

2.2 Device Dimensions

NOTE

Different devices may have different dimensions; Please refer to the actual product.

Figure 2-1 Dimensions (Unit:mm)

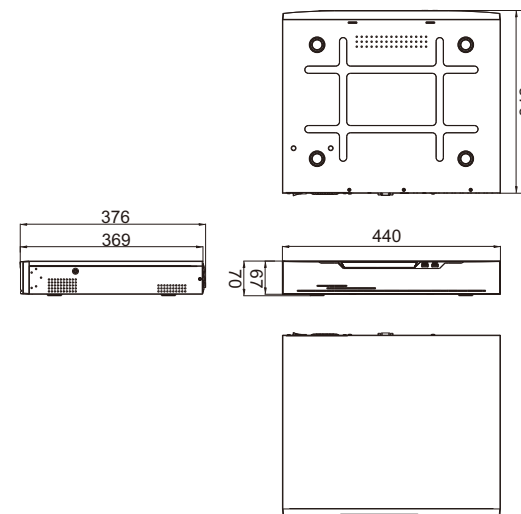

3 Device Installation

The hard disk of the NVR must be provided by the user. Take the following steps to install the hard disks:

- Remove the screws for fixing the cover and take down the cover.
- Put the hard disk under the hard disk bracket, hold the hard disk with one hand and aim the hard disk hole at the bracket hole, then fix the screws for hard disk (Install the hard disk near the fan first).

Figure 3-1 Installing the hard disk

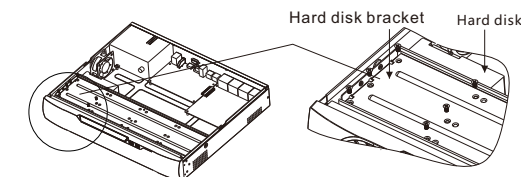

- Repeat step 2 to install other hard disks, and insert the hard disk data cables and power cables, then replace the upper cover and fasten the fixing screws.

4 Device Operation

4.1 Startup

Before starting NVR, ensure that the NVR is connected to a power supply properly and a monitor is connected to the HDMI or VGA interface of the NVR correctly. After starting the NVR, there is a login window located in the center, as shown in figure 4-1.

CAUTION In some environments, if the power supply is abnormal, the NVR may not work properly. In severe cases, the NVR may be damaged. In these environments, it is recommended to use regulated power supply.

Figure 4-1 Activation interface

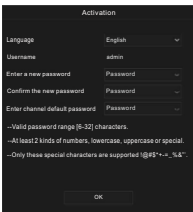
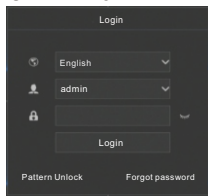

Figure 4-2 Login interface



NOTE

- The default name is admin, and NVR needs to activate, please create new password of device and channels to activate.
- Users can set pattern to unlock quickly.
- Users can change the system display language on the login window.

4.2 Topology of the NVR

The POE-type NVR supports direct access to POE cameras and automatically manages and assigns IP addresses. The POE Web end can be accessed over a LAN. Figure 4-3 shows the network topology of the NVR.

Figure 4-3 Topology of the NVR

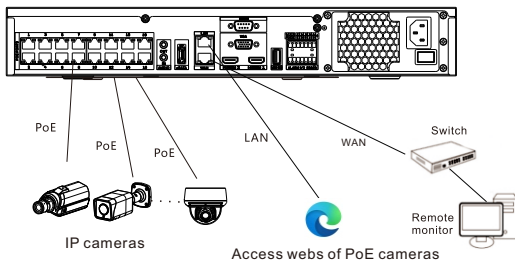

4.3 Special Function

Some functions are applicable for some special cameras, such as Microphone, Human thermometer, Smart, Intelligent Analysis, Advanced Intelligent Analysis, please refer to actual camera channels.

4.4 Power off

Enter the **Main Menu > System > Maintenance > Shutdown** to power off the NVR. Or turn off the power switch.

4.4 Quick menu

Put the mouse arrow on bottom of live video interface, the quick menu will be showing. You can set layout to view live video, switch the split screen, auto sequence, playback and so on.



5 Quick Configuration

Plug in power to access the NVR user page. The wizard window would show at first time, users can configure quickly or close immediately. For configuration details please refer to main menu.

Right-click on the main interface at any where to access the main menu. Main menu comprises Channel, Record, Alarm, Network and System settings, as shown in figure 5-1.

Figure 5-1 Main menu

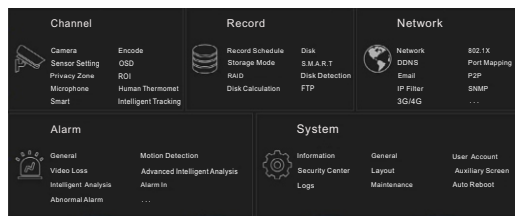

5.1 Channel

Channel settings contain Camera, Encode, Image, OSD, Privacy Zone, ROI (region of interest), Microphone, Human thermometer, Smart, and Intelligent tracking.

- Camera:** Users can add cameras automatically by clicking **Click to Add**, and add manually by clicking **Add**. Tick cameras then click **Delete** to delete cameras. Users can batch update software.
- Encode:** Users can set stream, encode type, resolution, frame rate, bit rate type, bit rate and so on.
- Sensor setting:** Adjust image parameters and users can set sensor parameter.
- OSD:** Customize time and channel name displaying in the live video page.
- Privacy Zone:** Set a privacy zone by clicking and dragging cursor and double-click an exist private area to delete it. Support up to 4 zones.
- Some of these settings can be copied to other channels by clicking **Copy** button.
- Microphone, Human Thermometer, Smart, and Intelligent Tracking** are the special functions for some models, not applicable for all cameras.

5.2 Record

Record settings contain Record Schedule, Disk, Storage, RAID, S.M.A.R.T, Disk Detection, Disk Calculation and FTP.

- Record Schedule:** Set record schedule and storage strategic. ANR is auto network recording, if the camera is plugged SD card and enabled record, if camera is disconnected, when the connection is recovered, NVR will copy the recording of the lost videos.
- Enter S.M.A.R.T interface to view the state of disks. Disk detection can detect the disks.
- RAID:** If users install more than four disks and want to keep the data safety, it is recommended to build RAID.
- Disk Detection:** Check the disk health status.
- Disk Calculation:** Two methods to calculate.
- FTP:** File Transfer Protocol, set the FTP path to save the alarm information if linkage to FTP.

NOTE

- Format the disk and all data on disk will be lost, please be careful to do this.
- Before replacing the hard disk, the power must be turned off.
- The disks of building RAID should be enterprise level, and the capacities are better at the same.
- For the safety of disks, please make sure the stabilization of power on.

5.3 Alarm

Alarm settings contain General, Motion Detection, Video Loss, Advanced Intelligent Analysis, Intelligent Analysis, Alarm in, Abnormal Alarm, Alarm out and Local intelligent analysis, as shown in figure 5-2.

Figure 5-2 Alarm

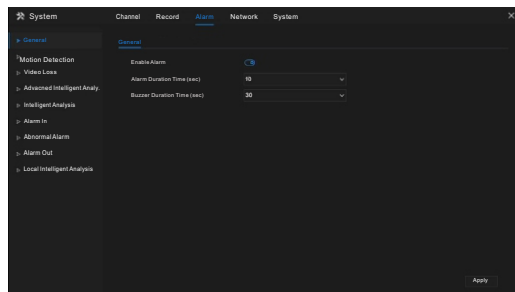

- General:** Enable or disable alarm and set duration time of alarm and buzzer.
- Motion Detection:** Enable this function, if detects any movement, it will alarm.

- Event actions:** Contain buzzer, alarm out, push message to App, pop-up message to monitor, send E-mail and post recording (after enabling, choose the recording time from drop list.)
- Area:** Set motion detection area. Press left button and drag the cursor to add a detection area, and double-click an area to delete it.
- Schedule:** Set schedule to enable or disable motion detection alarm. There are three methods to set: the first is clicking the double arrows button to choose all day. The second, click and drag the cursor to select periods. The third, click one by one.
- Video Loss, Intelligent Analysis** are same settings as motion detection. **Advanced Intelligent Analysis** is used for thermal cameras, alarms for smoker detection, smoke and flame detection and fire spot detection.
- Alarm In / Alarm out:** Settings for I/O alarming. **Abnormal Alarm** can tick disk error, IP conflict, network disconnected.
- Local Intelligent Analysis:** It is up to be set for 4 channels, set local intrusion parameter on NVR.

5.4 Network

Network settings contain Network, 802.1X, DDNS, E-mail, Port Mapping, P2P, IP Filter, SNMP, 3G/4G, PPPoE, Network Traffic and Platform Access, as shown in figure 5-3.

Figure 5-3 Network

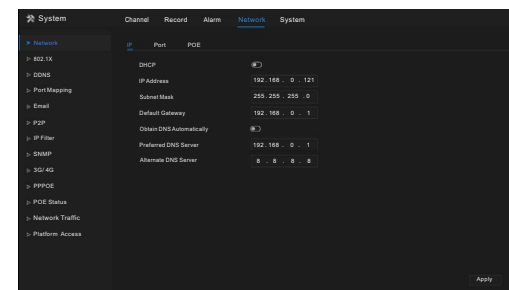

- Network, 802.1X, DDNS, and SNMP** interface to set network parameters.
- Email:** Set E-mails for sending and receiving alarm messages and password retrieval message.
- Port Mapping:** Set the ports for remote scanning.
- P2P:** Add NVR into device list of App by accessing the QR code.
- IP Filter:** Settings for creating black list or white list.
- 3G/4G:** Use 3G/4G modem plug to NVR provide the network.
- PPPoE:** Point to point network to access NVR directly.
- PoE Status:** View the online status of PoE cameras.
- Network Traffic:** View the send and receive rate of network.
- Platform Access:** Set URL parameters for accessing to CMS(Center Management System).

5.5 System

System settings contain Information, General, User Account, Security Center, Layout, Auxiliary Screen, Logs, Maintenance and Auto Reboot, as shown in figure 5-4.

Figure 5-4 System

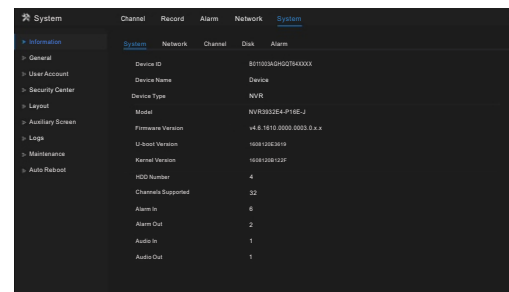

- Information:** View the basic information, such as System, Network, Channels, Disk, Alarm.
- General:** Include system, date and time, time zone, DST.
- User Account:** Add users and set advance setting (auto login, password double authentication, boot wizard).
- Security Center:** Modify the password, pattern unlock, secure Email, Secure question.
- Layout:** Add layouts to preview live video of the channels.
- Auxiliary Screen:** Use HDMI and VGA to view live video at the same time. HDMI port output acts as main screen.
- Logs:** Users can export logs (operating and alarm logs) if plug in a USB disk.
- Maintenance:** Include shutdown, reboot, exit system, reset, import configuration, export configuration and update.
- Auto Reboot:** Enable this function and the device will restart periodically.

5.6 Live Video

Enter the user name and password in the login interface, and click Login to enter the real-time video interface. As shown in Figures 5-5.

Figure 5-5 Live video

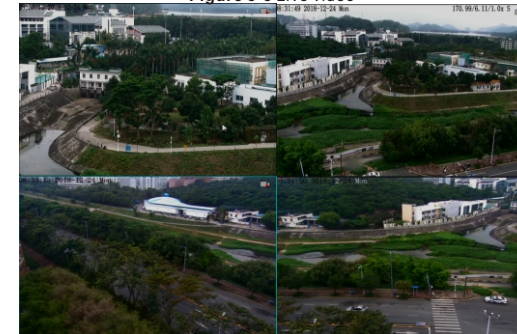

6 Mobile Client

Search for "InView Pro4" in App Store or Google Play to download and install the App. Use the App to scan the QR code, which you can find it on the backboard of the NVR and on P2P settings page (**Main menu>Network>P2P**) in user interface. Then input the NVR's user name and password to add the NVR to the device list. Users can manage the device on the APP.

7 Web Accessing

The NVR also can be accessed in a Web browser. Open a web browser like Chrome 45 and enter the IP address of device (The default IP address is 192.168.0.121) in the address box, and press **Enter**. The login page is displayed as shown in figure 7-1.

Figure 7-1 Login



NOTE

The user name and password are the same as the UI interface.