



SN-IPR8080DQAA-Z

8MP Active Deterrence Bullet Network Camera



Key Features

- 1/2.8" progressive scan CMOS
- Max. 8MP(3840 × 2160) @25/30 fps resolution
- True WDR, 3D DNR, ROI, HLC, BLC, Defog
- Support face, human, vehicle detection and capture
- Intelligent analytics: intrusion, single line crossing, double line crossing, loitering, wrong-way, people counting
- Built-in microphone and speaker
- Supports strobe-light and audible alarms linkage to warn intruders off
- 1/1 audio in/out, 1/1 alarm in/out
- Built-in SD card slot
- Smart IR distance up to 50 m
- IP66

Specification

Camera					
Image Sensor	1/2.8" Progressive Scan CMOS				
Max. Resolution	8MP (3840 × 2160)				
Electronic Shutter	Auto/Manual, 1/5 to 1/20,000 s				
Min. illumination	Color: 0.01 Lux @ (F1.6, AGC ON), B/W: 0 Lux @ (IR LED ON)				
Day & Night	IR cut filter				
Angle Adjustment	Pan: 0° to 360°, Tilt: 0° to 90°, Rotation: 0° to 360°				
Lens					
Lens Type	Motorized focus				
Iris	Fixed Iris				
Focal Length	2.7 to 13.5 mm				
F Number	F1.6				
Angle of View	H: 98.1° to 30.9°, V: 52.6° to 17.3°				
DORI					
DORI Distance	Lens	Detect	Observe	Recognize	Identify
	Wide	88 m (288.7 ft)	35.2 m (115.5 ft)	17.6 m (57.7 ft)	8.8 m (28.9 ft)
	Tele	280 m (918.6 ft)	112 m (367.5 ft)	56 m (183.7 ft)	28 m (91.9 ft)
Illuminator					
Illuminator Type	IR				
Illumination Distance	Up to 50m (164.0 ft)				
Illumination On/Off Control	Auto/Manual				
Video					
Streaming Capability	3 Streams				
Stream/Frame Rate	Stream1: 3840 × 2160, 2592 × 1944, 2592 × 1520, 2560 × 1440, 2304 × 1296, 1920 × 1080, 1280 × 720 @25/30 fps Stream2: D1, VGA, CIF @25/30 fps Stream3: VGA, CIF, QVGA @25/30 fps				
Bit Rate Control	CBR/VBR				
Bit Rate	Stream1: 200 kbps to 16 Mbps Stream2: 100 kbps to 6 Mbps Stream3: 100 kbps to 3 Mbps				
Region of Interest	Off/On (8 areas, Rectangle)				
Smart Encode	Support				
Audio					
Compression	G.711, RAW_PCM				
Bit Rate	64Kbps (G.711), 128Kps (RAW_PCM)				
Image					
Image Adjustment	Brightness, Sharpness, Contrast, Saturation adjustable				
Aisle Mode	Support				
Mirror	Support				
White Balance	Auto/Manual				

Day/Night Setting	Auto, Day, Night, Time
Smart IR	Support
Noise Reduction	2D/3D DNR
Image Enhancement	HLC, BLC, Defog
Wide Dynamic Range	True WDR
S/N Ratio	55dB
Motion Detection	Support
Privacy Masking	4 areas
Smart Function	
Multi-Object Detection	Supports face, human, vehicle detection and capture
Intelligent Analytics	Intrusion, Single line crossing, Double line crossing, Loitering, Wrong-way Support alarm triggering by specified target types (human and vehicle)
People Counting	Support
Smart Alarm	When an alarm is triggered, active strobe light and audible alarm to warn intruders off.
Network	
Protocols	IPv4/IPv6, 802.1x, HTTP, HTTPS, TCP/IP, UDP/IP, RTSP, DHCP, NTP, RTCP/RTP, PPPoE, SMTP, DNS, UPnP, FTP, ARP, SNMP, TLS/SSL
Interoperability	ONVIF, SDK, CGI
Streaming Method	Multicast
Max. User Access	10 Users
Web Viewer	<IE11, Chrome, Firefox, Microsoft Edge
Language	English, Chinese, Polish, Italian, Portuguese, Spanish, Russian, French, Czech, Hungarian. Default: English
Interface	
Network Interface	1 Ethernet (10/100 Base-T) RJ-45 Connector
Built-in Microphone	Support
Built-in Speaker	Support
Audio Interface	1ch Input, 1ch Output
Alarm Interface	1ch Input, 1ch Output
Reset Button	Support
SD Card Slot	Built-in, up to 256GB
Electrical	
Power Supply	DC12V (-15% to +25%)/PoE (IEEE 802.3af)
Power Consumption	Max 14.5 W
Operating Temperature	-40°C to 55°C (-40°F to 131°F)
Operating Humidity	Less than 90% RH
Ingress Protection	IP66
Certifications	CE/FCC
Casing	Metal
Dimensions	303 × 100 × 107 mm (11.92 × 3.94 × 4.21 inch)
Net Weight	1.25 kg (2.76 lb)

Dimensions (mm)

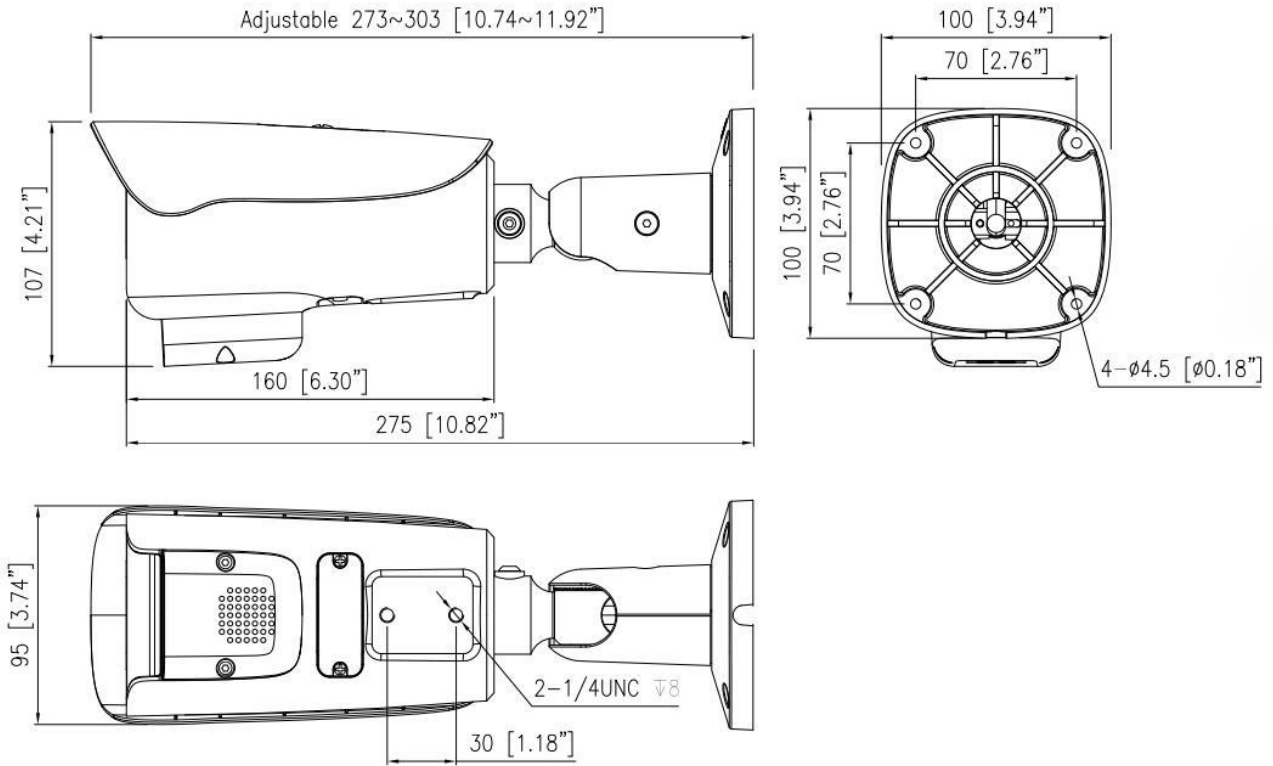

Accessories

Optional:



SN-CBK649B
Junction Box



SN-CBK627D
Pole Mount